

PROJECT NAME: \_\_\_\_\_ CAT. #: \_\_\_\_\_  
 NOTES: \_\_\_\_\_ FIXTURE SCHEDULE: \_\_\_\_\_

# Round Network BLE Nodes & Sensors

## Sharkward Overview

The Sharkward Bluetooth Lighting Control provides automated individual and group control of light fixtures using on sensors and Bluetooth sigmesh technology .

The BRI823-B-D-BLE mounted in an Commercial lighting fixture and provides multi-level control solution based on motion and or daylight harvesting contribution.



BRI823-B-D-BLE

## Applications:

- Car Parking
- Hospitals
- Schools
- Warehouses
- Industrial

## Features

- Lighting controls meet design lights consortium (DLC) networked lighting control system technical requirements (Version NLC5 June 23, 2020).
- Quicky connect and adjust different sensor angle.
- Easy commissioning with tuya/sharkward App (Available in IOS and Android).
- Bluetooth network with SaaS working by computer
- Individual addressability and/or grouping.
- Time clock scheduling for individual lights, groups or scenes.
- Multi-level dimming: manual ON/OFF automatic ON/OFF, and automatic partial ON/OFF ,daylight harvesting control capability.
- 5 Year Warranty

## PIR Sensor Features

DAYLIGHT HARVESTING	ON/OFF
MOTION SENSING	ON/OFF
FIRST TIME DELAY	1-59 minutes/infinite
SECOND TIME DELAY	0-59 minutes/infinite
DIM LEVEL	0-100%
MOUNTING HEIGHT	13-40ft
DETECTION RANGE	Up to 52ft diameter
DETECTION HORIZONTAL PATTERN	360°
DETECTION VERTICAL PATTERN	90°

## Ordering Information

MODEL NUMBER	DESCRIPTION
BRI823-B-D-BLE	NETWORK NODE Round, WHITE



5-year standard warranty (further details available at [www.sharkward.com](http://www.sharkward.com)) Product may be eligible for a warranty extension to 10 years, for an additional fee. Contact sharkward for details.

PROJECT NAME: \_\_\_\_\_ CAT. #: \_\_\_\_\_  
 NOTES: \_\_\_\_\_ FIXTURE SCHEDULE: \_\_\_\_\_

# Round Network BLE Nodes & Sensors

## Specifications:

	BRI823-B-D-BLE
NETWORK BLE SIGMESH	Yes
DAYLIGHT HARVESTING	Yes
DIGITAL PIR MOTION SENSOR	Yes
DETECTION MODE	Occupancy/Vancancy/Bi-level in 1 Unit
OPERATING VOLTAGE	120/277V AC
MAXIMUM LOAD	5A, 600W Max. for LED driver only
SINKING CURRENT	max. 25mA
CONTROL OUTPUT	0-10V
RADIO FREQUENCY	2.4GHz ± 75MHz
WIRELESS STANDARD	BLE 4.2 MESH IEEE 802.15.1
PROGRAMMING	Tuya/sharkward App mobile app(iOS and android) or SaaS
CYBERSECURITY	UL1376
ENCRYPTION	AES 128-bit
MESH RANGE	100ft node-to-node and 50ft node-to-device (Commissioning)
SAFETY	cULus Listed
FCC	FCC ID:
OPERATING TEMPERATURE	-40°F ~ +158°F (-40°C ~ +70°C)
IP RATING	IP65
COLOR	White

\*Must be paired with a Network Wall Switch

## Product Dimensions

### BRI823-B-D-BLE

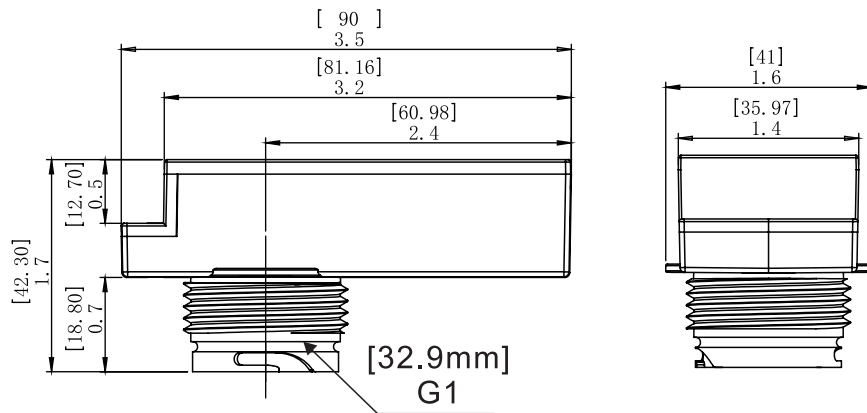

5-year standard warranty (further details available at [www.sharkward.com](http://www.sharkward.com)) Product may be eligible for a warranty extension to 10 years, for an additional fee. Contact sharkward for details.

PROJECT NAME: \_\_\_\_\_ CAT. #: \_\_\_\_\_  
 NOTES: \_\_\_\_\_ FIXTURE SCHEDULE: \_\_\_\_\_

# Round Network BLE Nodes & Sensors

## Wiring

### BRI823-B-D-BLE

BRI823-B-D-BLE wiring with dimming ballast or LED driver.

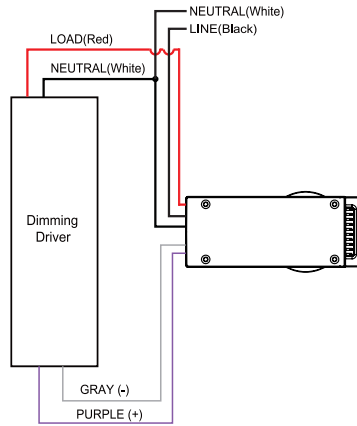

## Detection Coverage

### BRI823-B-D-BLE

L3

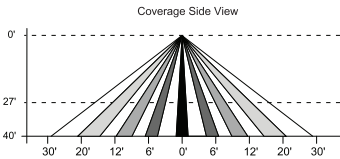

360° Coverage

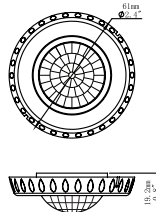
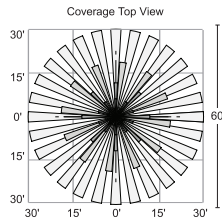

L4

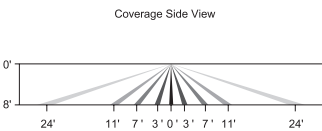

360° Coverage

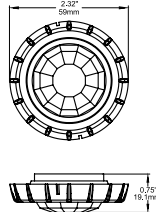
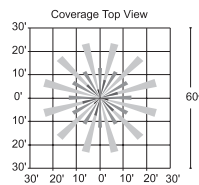

## Commissioning

Tuya/Sharkward mobile App makes it easy to pair devices, create groups, set scenes/schedules, customize dimming levels, and adjust high trim based on application needs.



5-year standard warranty (further details available at [www.sharkward.com](http://www.sharkward.com)) Product may be eligible for a warranty extension to 10 years, for an additional fee. Contact sharkward for details.