



WARNING

PLEASE READ ALL INSTRUCTIONS BEFORE ATTEMPTING INSTALLATION

- To prevent personal injury or product damage only licensed electricians should install.
- To avoid electric shock or component damage disconnect power before attempting installation or servicing.
- This product must be installed in accordance with the national electric code (NEC) and all applicable federal, state and local electric codes and safety standards.
- Disconnect product and allow cooling prior to servicing.
- Any alteration or modification of this product is expressly forbidden as it may cause serious personal injury, death, property damage and/or product malfunction.
- To prevent product malfunction and/or electrical shock this product must be properly grounded.
- This luminaire is designed to operate in ambient temperatures ranging from -40°C to 45°C and to be horizontally mounted with the LEDs facing down.
- This product must be installed in accordance with the applicable installation code by a Person familiar with the construction and operation of the product and the hazards involved.
- MIN 75°C SUPPLY CONDUCTORS
- CONSULT A QUALIFIED ELECTRICIAN TO ENSURE CORRECT BRANCH CIRCUIT CONDUCTOR
- CAUTION - RISK OF FIRE
- Adjustable Arm/Slipfitter/Yoke Mounted with PHOTOCCELL function tilt angle should not exceed 15 degrees
- This product is not available for several special environments, such as places with corrosive gas liquids or high pressure water vapor.

Square/Round Pole Mount

1. Remove the side plate from mounting bracket.
2. Fix the bracket to the pole with 2pcs 3/8 screws.
3. Route the cord into mounting bracket through the hole for wiring, slide the fixture onto the bracket and tighten 2pcs bottom screws.
4. Slightly drag the wires to make sure the hole on bracket is sealed by silicon gasket.
5. Make wiring connection as per wire diagram below, replace the side plate and fasten screws.

Silicone gasket usage instructions:
First, only use silicone gasket A while using a round pole, Second, you need to use two silicone gaskets at the same time while using a square pole.

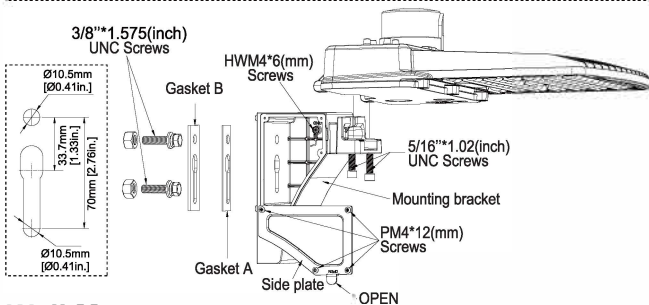

Wall Mount

1. Remove the side plate by loosen the screws.
2. Fix the steel plate onto the mounting bracket with KM4*10 screws provided.
3. Use the back plate provided to locate footprint on the wall to drill the holes, then fix the bracket on the wall with screws.
4. Route the power cord into wall mount bracket, slide the fixture onto the mounting bracket, then tighten 2pcs bottom screws.
5. Make wiring connection inside of bracket and replace the side plate with screws.

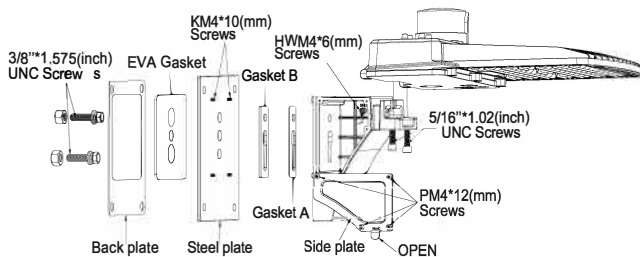

Yoke Mount

1. Mount fixture onto surface using the hole pattern provided on the trunnion bracket.
2. Loosen center bolts and set screw.
3. Rotate fixture to desired aiming position and tighten center bolts.
4. Make wiring connection as per wire diagram below.
5. After fixing the bracket at certain angle, the four Hexagon socket screws should be locked by manual wrench

Adjustable Arm Mount

1. Remove the bracket cover 6 pcs PM4*12 screws.
2. Fix the bracket to the light pole with 2 pcs 1-3/8 screws.
3. Loosen the screws of M10 and adjust the appropriate angle.
4. Thread the fixture input wire through the bracket.
5. Install the fixture on the bracket and lock the screws.
6. Complete the wiring according to the wiring diagram.
7. Arrange the power cord and install 2 face covers, taking care that the power cord is not exposed and does not press the wire.

Silicone gasket usage instructions:
First, only use silicone gasket A while using a round pole, Second, you need to use two silicone gaskets at the same time while using a square pole.

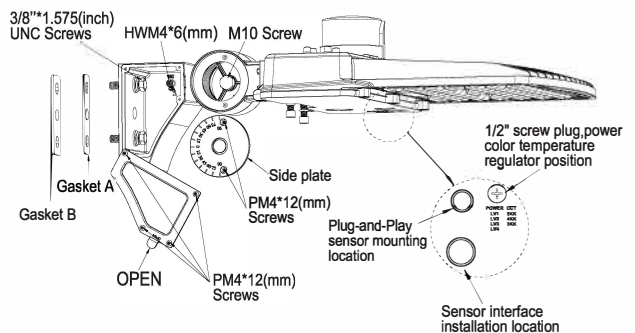

Slipfitter Mount

1. Connect the wires to L / N / GND
2. Remove the cover and adjust the bracket to the desired angle
3. Install the bracket on the pole and fix it with screws

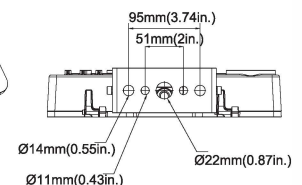
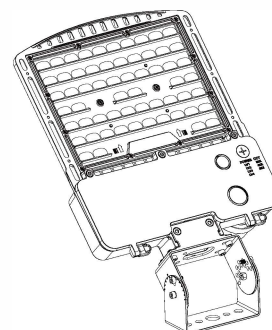
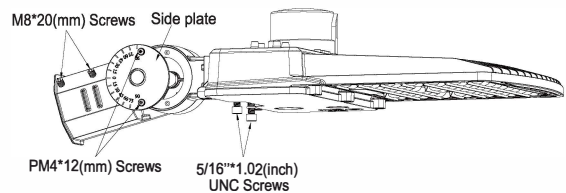

Power and CCT selectable version

1. Remove the 1/2" screw plug on the bottom of the fixture.
2. Select Power(White) and CCT(Black) by sliding the respective switch to the desired value according to the figure.
3. Replace the 1/2" screw plug and tighten with a flat head screwdriver.

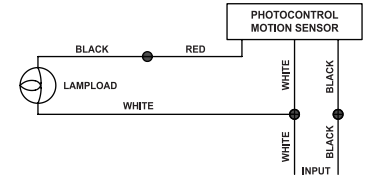
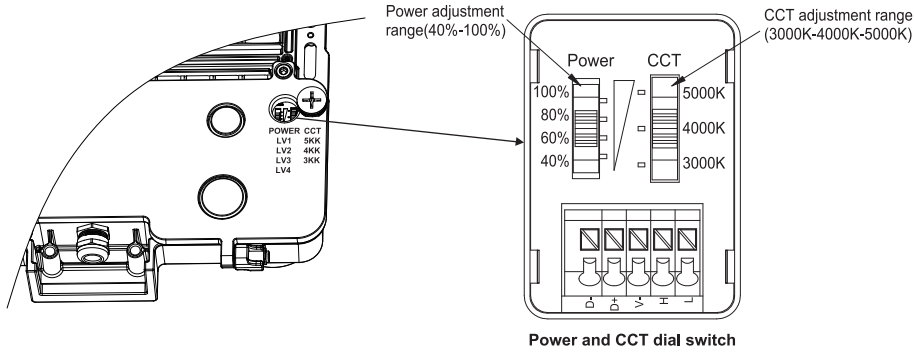

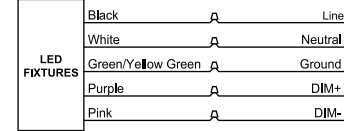

WIRING DIAGRAM

Note: Two dimming wire in the driver box

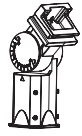
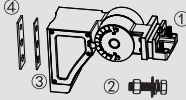
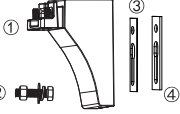
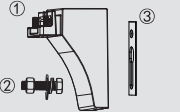
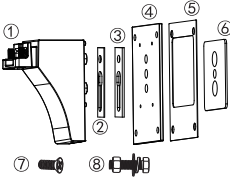

ACCESSORY LIST

Mounting Type	Accessory	Specifications	Quantity
 Slipfitter mount	Slipfitter	Adjustable slipfitter	1
 Adjustable Arm Mount	① Adjustable Arm Mount	235 x 90 x 152mm Adjustable Arm Mount	1
	② Bolt	# 3/8"*1.575" Stainless Steel Hexagon Hexagon head bolt	2
	③ Gasket A	L100W22H2 Gasket	1
	④ Gasket B	L100W30H3 Gasket	1
 Square mount	① Pole Mount Arm	135 x 177 x 96mm Square pole mount arm	1
	② Bolt	# 3/8"*1.575" Stainless Steel Hexagon Hexagon head bolt	2
	③ Gasket A	L100W22H2 Gasket	1
	④ Gasket B	L100W30H3 Gasket	1
 Round mount	① Pole Mount Arm	135 x 177 x 96mm Square pole mount arm	1
	② Bolt	# 3/8"*1.575" Stainless Steel Hexagon Hexagon head bolt	2
	③ Gasket A	L100W22H2 Gasket	1
 Wall mount	① Pole Mount Arm	135 x 177 x 96mm Square pole mount arm	1
	② Gasket A	L100W22H2 Gasket	1
	③ Gasket B	L100W30H3 Gasket	1
	④ Wall Mount Plate	203 x 152 x 5mm Steel Plate	1
	⑤ Wall Mount Template	188 x 144 x 0.5mm Back Plate	1
	⑥ EVA Gasket	L119W119H3,40°EVA Gasket	1
	⑦ Bolt	KM4 x 10" Stainless Steel flat head bolt	4
	⑧ Bolt	# 3/8"*1.575" Stainless Steel Hexagon head bolt	2
 Yoke mount	Yoke Bracket	L129.5W60H88 upper bracket + L138W60H88 lower bracket + L44.5W115H49 bracket	1
Others	Twist-lock photocell	120-277V 3-Pin	1
	Receptacle	3-Pin receptacle	1
	Occupancy Sensor	120-277V 0-10V Bi-level	1