

LSVT

Project Name:	
Type:	



APPLICATION

Designed to deliver an unprecedented uniformity and functionality, this LED slim volumetric troffer features a compact yet sturdy aluminum construction designed to blend into modern architectural spaces. This creates a soft and comfortable lighting experience for commercial and institutional spaces including open offices, classrooms, retail and healthcare facilities, goes beyond what was previously possible with traditional LED luminaires.

FEATURES:

- Featuring a low profile form factor, it is ideal for buildings with a low plenum space and is suitable for all standard 1x4, 2x2 or 2x4 grid ceilings.
- LSVT provides quiet and smooth illumination for visual comfort while maximizing efficiency.
- Low profile design.
- Uniform and soft illumination with back-lit technology.
- Extruded aluminum housing with powder coat white finish provides long term performance and superior aesthetic.

MOUNTING:

- T-Grid Recessed Ceiling Mount. Compatible with standard 15/16" T-bar, 9/16" T-bar, 9/16" Slot, 9/16" Interlude.
- Optional flange kit available(field install).

LED:

- Lumen efficiency ≥ 110 lm/W
- Field adjustable color temperature: 3500/4000/5000(K)
- Field adjustable wattage.
- CRI: >80
- Life span: $\geq 50,000$ hours (LM80@25°C)

ELECTRICAL:

- 0-10V dimming, down to 10%
- 120-277V, 50/60Hz
- Power factor: >0.9
- THD: $<20\%$
- Operating ambient temperature: -4°F to 104°F (-20°C to 40°C)

LISTING:

- cULus listed for damp locations.
- Tested to IESNA LM-79 and LM-80,
- DesignLights Consortium Qualified and classified for DLC standard/premium. ¹
- 5 years limited warranty.

CONFIGURATIONS

Size	LED Watts	Lumen Output (3500/4000/5000K)	Lumen Efficiency (3500/4000/5000K)
1' x 4'	L35	3860lm/ 3879lm/ 3937lm	110.3/ 110.8/ 112.4 lm/W
	L30	3309lm/ 3324lm/ 3372lm	
	L25	2757lm / 2770lm/ 2810lm	
2' x 2'	L35	4084lm/ 4104lm/ 4165lm	116.7/ 117.2/ 119 lm/W
	L30	3501lm/ 3516lm/ 3570lm	
	L25	2917lm / 2930lm/ 2975lm	
2' x 4'	L50	5678lm/ 5706lm/ 5791lm	113.5/ 114/ 115.8 lm/W
	L40	4540lm/ 4560lm/ 4632lm	
	L30	3405lm/ 3420lm/ 3474lm	

* Indication that the lumen output is nominal.

LSVT

ORDERING INFORMATION

EXAMPLE: LSVT-14-3S-3T-UNV

MODEL	SIZE		LED		COLOR TEMP.		MOUNTING		VOLTAGE	
LSVT	14	1' x 4'	3S	Selectable 25/30/35W LED	-3T	Selectable 35/40/50K	(Blank) FK	Recessed Drywall flange kit (field install)	UNV	120-277V
	22	2' x 2'								
	24	2' x 4'	3SH	Selectable 30/40/50W LED						

OPTIONS		LIGHTING CONTROL SYSTEM	
EMI15	1875 LUMEN EM Battery Backup	PPA102S	<Bluetooth> Bluetooth Powerpack (Consult factory for installation location)
EMI25	3125 LUMEN EM Battery Backup		
REM15	15W EM For Field Install		
REM25	25W EM For Field Install		

NOTES:

1. DesignLights Consortium® (DLC) qualified product. Not all versions of this product may be DLC qualified. Please check the DLC Qualified Products List at www.designlights.org/QPL to confirm which versions are qualified.



Selectable

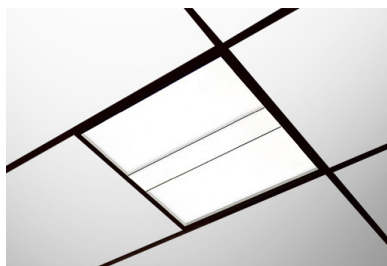

LSVT

DIMENSION

2x2

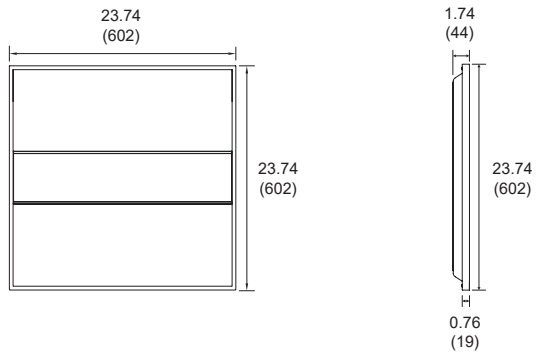

2x4

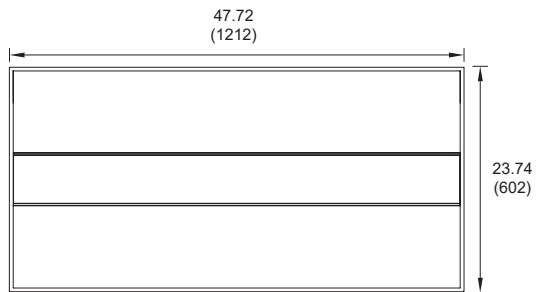

1x4

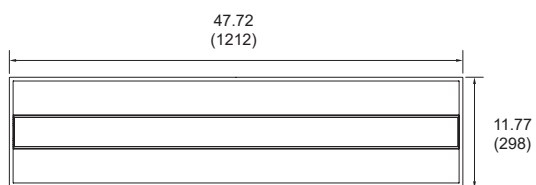

All dimensions are in inches (millimeters).

T-GRIDS CEILING COMPATIBILITY

It is architectural recessed lighting solution that compatible with most 15/16" and 9/16" t-grid systems for commercial and institutional environment. The following are only as some common examples to show.

9/16" Flat

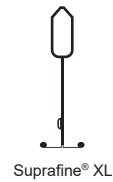

9/16" Slot

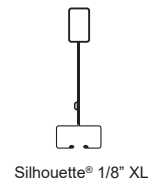
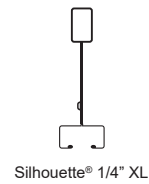

9/16" Interlude

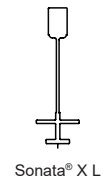
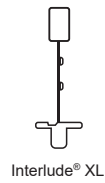

15/16" Flat

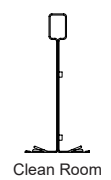
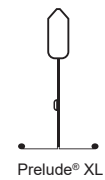

*Please verify compatibility with factory.

LSVT

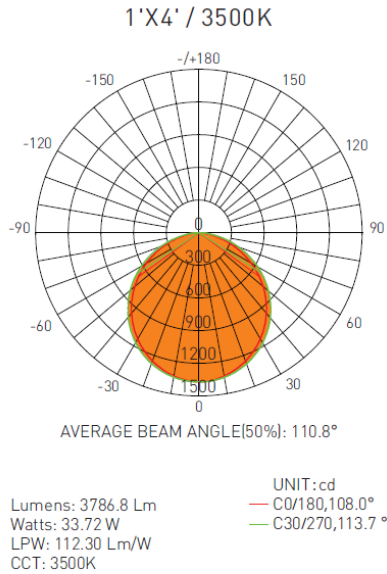

Zonal Flux Diagram

T	C0	C45	C90	C135	C180
10	1336	1347	1348	1340	1336
20	1254	1271	1281	1261	1252
30	1127	1150	1170	1138	1126
40	963.6	989.3	1020	978.3	964.1
50	769.5	795.2	834.4	786.5	771.1
60	551.3	576.8	620.4	571.2	554.9
70	322.2	345.0	387.4	343.2	327.4
80	102.7	128.4	159.0	128.4	111.3
90	0	0.0247	0.5103	0.0435	0
100	0	0	0.5118	0	0
110	0	0	0.5112	0	0
120	0	0.3431	0	0	0
130	0	0.5709	0	0.2935	0.2782
140	0	0.7287	0	0.4054	0.4477
150	0.0863	1.378	0	0.5128	0.6047
160	0.3184	1.551	0	1.301	0.7618
170	1.149	2.584	0.0846	0.398	1.383
180	1.209	2.671	0	2.658	1.468
DEG	LUMINOUS INTENSITY:cd				

Zonal Lumens

T	φ total
0-10	129.4
10-20	498.5
20-30	1056
30-40	1724
40-50	2412
50-60	3025
60-70	3482
70-80	3729
80-90	3784
90-100	3784
100-110	3785
110-120	3785
120-130	3785
130-140	3785
140-150	3786
150-160	3786
160-170	3787
170-180	3787
	UNIT: lm

Luminance cd/(m2)

G(DEG)	C0/180	C90/270
85	4497	7271
80	5915	9158
75	8087	10431
70	9427	11330
65	10340	11958
60	11033	12412
55	11548	12744
50	11979	12985
45	12309	13172

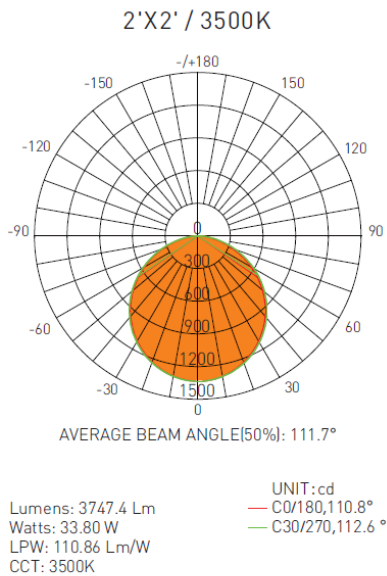

Zonal Flux Diagram

T	C0	C45	C90	C135	C180
10	1308	1309	1311	1307	1306
20	1233	1236	1242	1233	1232
30	1118	1121	1132	1118	1115
40	964.2	968.6	983.4	966.3	961.9
50	777.6	785.4	802.5	783.2	777.2
60	566.6	575.9	594.9	575.0	568.6
70	344.4	354.0	372.1	354.2	346.5
80	128.7	139.2	154.9	139.9	132.6
90	0	0	0	0	0
100	0	0	0	0	0
110	0	0	0	0	0
120	1.021	0.0582	0.0031	0.0692	0.3140
130	1.326	0.1745	1.151	0.0346	0.9394
140	1.302	0	1.281	0	1.406
150	1.213	0	0.7683	0	1.452
160	0.8069	0	0.7699	0	1.452
170	1.023	0.1111	0.7715	0	1.452
180	1.196	0.1708	0.9402	0	1.452
DEG	LUMINOUS INTENSITY:cd				

Zonal Lumens

T	φ total
0-10	126.1
10-20	486.2
20-30	1031
30-40	1686
40-50	2364
50-60	2972
60-70	3430
70-80	3686
80-90	3745
90-100	3745
100-110	3745
110-120	3745
120-130	3746
130-140	3746
140-150	3747
150-160	3747
160-170	3747
170-180	3747
	UNIT: lm

Luminance cd/(m2)

G(DEG)	C0/180	C90/270
85	4616	6897
80	7416	8919
75	8994	10072
70	10072	10875
65	10794	11451
60	11335	11895
55	11773	12229
50	12101	12481
45	12370	12675

LSVT

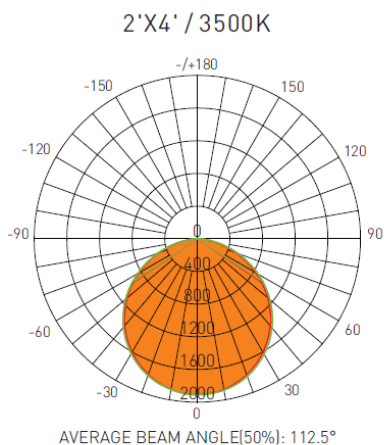

Lumens: 5425.2 Lm
 Watts: 48.74 W
 LPW: 111.32 Lm/W
 CCT: 3500K

UNIT: cd
 — C0/180, 111.5°
 — C30/270, 113.6°

Zonal Flux Diagram

T	C0	C45	C90	C135	C180
10	1871	1885	1882	1874	1870
20	1768	1790	1790	1772	1766
30	1605	1631	1635	1609	1603
40	1388	1414	1424	1393	1387
50	1123	1147	1161	1129	1124
60	821.0	840.5	860.8	829.1	824.3
70	500.1	515.0	538.1	508.5	504.0
80	185.1	205.2	225.2	204.5	198.1
90	0.0436	0.4280	1.015	0.3364	0
100	0	0.2581	0.7634	0	0
110	0.2049	0.3759	1.199	0.2440	0.2564
120	0.3209	0.4964	0	0.2991	0.4912
130	0.6043	0.4431	0	0.3249	0.9462
140	0.5623	0	0	0	1.032
150	0.5230	0	0	0	1.032
160	0.5951	0	0.1246	0	1.032
170	0.7622	0	0.1512	0.1108	1.032
180	0.6881	0	0.1698	0.1699	0.8602
DEG	LUMINOUS INTENSITY:cd				

Zonal Lumens

T	Φ total
0-10	180.6
10-20	697.7
20-30	1482
30-40	2429
40-50	3410
50-60	4293
60-70	4959
70-80	5333
80-90	5423
90-100	5423
100-110	5424
110-120	5424
120-130	5425
130-140	5425
140-150	5425
150-160	5425
160-170	5425
170-180	5425
	UNIT: lm

Luminance cd/(m2)

G(DEG)	C0/180	C90/270
85	7012	10530
80	10671	12962
75	13070	14547
70	14634	15729
65	15670	16562
60	16434	17211
55	17045	17696
50	17492	18060
45	17844	18351