

RONDO2

Rotational LED

Project Name:	
Type:	



APPLICATION

The RONDO is a featured Architectural Linear fixture. Housing is formed by extruded aluminum with a highly reflective die-formed white painted steel reflector. The click-in acrylic lens has a matte finish and a diffuser which is removable for maintenance. It is used for multiple applications such as commercial, general office, banking, retail and educational environments.

MOUNTING:

- Pendant.
- Wall mount.

LED:

- High quality array LEDs.
- LM80
- Color Temperature: 2700/3000/3500/4000/5000 (K).
- Color Rendering Index: > 80 (optional >90).
- Nominal Lamp Life: 100,000 hours.
- Reported L70 hours: +60,000 (55°C).

ELECTRICAL:

- High power factor electronic driver, operate from a 120 ~ 277 Vac input range, 50 / 60 Hz.
- Features included over voltage protection, surge, short circuit protection and over load protection.
- Power Factor: typical > 0.95, THD <20, meets Class1 or Class 2 circuit.
- 0-10V dimmable driver as standard.
- 0-10VDC dimming 1%~100%.
- Operating temperature: -4°F (-20°C) ~ 122°F (50°C).

FINISH:

- Standard powder-coat textured white painted finish on exposed trim, consult factory for custom colors.
- Comes with snap-in acrylic lens as standard.

LISTING:

- UL / CUL listed.
- UL listed for dry & damp location.
- Assembled in USA (optional).
- BAA compliant (optional).
- 5 years limited warranty.
- 7 or 10 years limited warranty. (optional) ⁶
- Bluetooth Mesh System available, please contact factory for more information.

CONFIGURATIONS

Series	Size	Model #	AC Input	Fixture Lumen Output (4000K)	Lumen Efficiency (4000K)
RONDO2	2'	18L	9.9W	1197.9 lm	121 lm/W
		27L	14.85W	1796.8 lm	
		36L	19.8W	2395.8 lm	
		48L	26.4W	3194.4 lm	
		54L	29.7W	3593.7 lm	
	3'	18L	14.85W	1796.8 lm	
		27L	22.27W	2694.6 lm	
		36L	29.7W	3593.7 lm	
		48L	39.6W	4791.6 lm	
		54L	44.55W	5390.5 lm	
	4'	18L	19.8W	2395.8 lm	
		27L	29.7W	3593.7 lm	
		36L	39.6W	4791.6 lm	
		48L	52.8W	6388.8 lm	
		54L	59.4W	7187.4 lm	
	8'	18L	39.6W	4791.6 lm	
		27L	59.4W	7187.4 lm	
		36L	79.2W	9583.2 lm	
		48L	105.6W	12777.6 lm	
		54L	118.8W	14374.8 lm	

CCT	Multiplier		
	3000K	3500K	5000K
Down only	0.9642	0.9822	1.0357

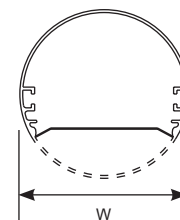

Specifications: RONDO2

Width: 2-1/2 Dia. (63)

All dimensions are in inches (millimeters).

ORDERING INFORMATION

EXAMPLE: RONDO2-IND-4-27L-30K-UNV

MODEL	ROW ¹	SECTION ²	LED
RONDO2-IND (Individual Mount) RONDO2-CON (Continuous Row Mount)	xx Specify nominal overall row length in 1' increments (Continuous runs)	2 2' Length 3 3' Length 4 4' Length 8 8' Length ³ X Custom Length ¹⁰	18L 18W LED (598 lm/ft) 27L 27W LED (898 lm/ft) 36L 36W LED (1197 lm/ft) 48L 48W LED (1597 lm/ft) 54L 54W LED (1796 lm/ft) NL Non-Lit
RONDO2-SQ (Square)	X'x''-Y'y'' Specify dimensions in inches (Minimum required dimensions is 2'4"-2'4", 2' increments), (Straight joint provided over 8ft run in length). * Must provide a sketch on the last page.		* Contact factory for custom wattage or lumen requirement.
RONDO2-CM (Custom)	Refer to dimensions page to calculate the total run * Must provide a sketch on the last page.		

RONDO2

COLOR TEMP.		CRI		ANGLE		MOUNTING		VOLTAGE		EM SECTION ⁴	
-27K	2700K ¹²	(Blank)	80+ CRI	(Blank)	Down	(Blank)	Pendant	UNV	120-277V	(Blank)	None EM
-30K	3000K	C9	90+ CRI ⁷	45	45°	W5	5" Wall Mount	120	120V	1SE	1 Section
-35K	3500K			90	90°	W12	12" Wall Mount	277	277V	2SE	2 Section
-40K	4000K			135	135°			347	347V ⁸	xSE	x Section
-50K	5000K			180	180°						

FIXTURE FINISH		CORD FINISH		CANOPY FINISH		CEILING TYPE		SUSPENSION LENGTH	
(Blank)	Matte White RAL#9003 (Std.)	(Blank)	White (Std.)	(Blank)	White (Std.)	X1	15/16" grid T-bar ceiling	AC48	Adjustable Aircraft Cable Canopy 48"L
*BK	Black RAL #9011	*BKC	Black	*BC	Black Canopy	X2	Hard ceiling	AC96	Adjustable Aircraft Cable Canopy 96"L
**CC	Custom Color			*SC	Silver Canopy	X3	Sloped Hard ceiling	ST24	Stem Canopy 24"L
*AMB	Anti-Microbial Coating (Matte Skye White)			**CSS	Custom Canopy Color (White is Std.)	X4	9/16" T-bar ceiling	ST48	Stem Canopy 48"L
<small>* Non-standard finish with extra charge. ** Additional charge & set up fee.</small>								<small>* Contact factory for custom length.</small>	

LED DRIVER		OPTIONS	
(Blank)	0-10V dim to 1% (Std.) (dim both uplight and downlight simultaneously)	EM-10LED	Integrated 1620 LUMEN EM Battery Backup ⁹
ES566	eldoLED SOLOdrive Natural Dimming to dark, 0-10V, 100% ~ 0.1% dim	GTD	Bodine Generator Transfer Device
SD40	40% / 100% Bi-Level Step dim	GTD10DIM	Bodine Generator Transfer Device (0-10VDC Dimmer Override)
SDXX	XX% / 100% Bi-Level Step dim (Specify XX : 10% ~ 70%)	ARRA	Assembled in USA for Buy American Act
PHSR	Philips Xitanium Sensor-Ready, Dali 5%~100% dim.	BAA	BAA(Buy American Act) and BABA(Build America Buy America) compliant
PHDL	Philips Xitanium DALI driver, Dim to 5%	O7W	Optional 7 Years Limited Warranty ⁵
TDM	Triac Dim. (120V only)	O10W	Optional 10 Years Limited Warranty ⁵
TD30/70	30% / 70% / 100% Tri-Level Step dim	AMS	Bluetooth Mesh Wireless Sensor. Occupancy/Daylight/0-10V Dimming
TDXX/YY	XX% / YY% / 100% Tri-Level Step dim (Specify XX, YY : 10% ~ 70%)	DPMS	Daylight Dimming Photo Sensor (0-10 VDC Control), (LSR-301-S required if FD-301 is installed) ¹¹
LDE1	Hi-lume 1% EcoSystem LED driver with Soft-on, Fade-to-Black dimming technology, 100% ~ 1% dim	LSR-301-S	Setup Remote Control for DPMS (Required for DPMS)
ELV	ELV compatible (reverse-phase or trailing-edge), (120V only)	LSR-301-P	Occupant Remote Control for DPMS
TRIO1	Tridonic IoT ready, 1-100% dim via Smart Module Interface (SMI), automated dimming/lighting controls via Enlighted Sensor Interface	SO	Dimming Wires connected to Sensor Only (available option on FS-205 non-Bluetooth AMS sensor only) ⁵
DMX	DMX512 control system (Only available with RGB+W option)	LC	Non-lit 90° coupling
DLM	Wattstopper's DLM interface (Only available with RGB+W option)	TC	Non-lit T-shape coupling
LTEA2W	Hi-lume 1% 2-wire LED driver (120V forward phase only)	XC	Non-lit X-shape coupling
BLT	Bluetooth Mesh System (contact factory for more information)	LC-VD	Non-lit 90° vertical drop
		LC-BT	Non-lit 90° bottom
		TC-VD	Non-lit T-shape vertical drop

LIGHTING CONTROL SYSTEM	
LUTRON VIVE	<p><Lutron Vive System Enabled></p>  <p>Click Here!</p>
IFS105SE	<Bluetooth> Bluetooth Mesh Wireless Sensor. Occupancy/Daylight/0-10V Dimming
PPA102S	Bluetooth Powerpack (Consult factory for installation location)

NOTES:

- Specify only when Continuous Row Mount.
- No need to select, if same as row length and section length.
- Comes with 1pc 8ft lens.
- EM is installed in last 4' of luminaire sections. Separate section required 2SE or specified. Must specify voltage, not available with 347V.
- This limited warranty covers electrical parts only and does not apply to labor, equipment lease, or defect from improper installation or operation.
- Dimming wires provided and connected to sensor only, not for dimmer switch. (available with AMS and DPMS option)
- Lumen per watt is around 15% less than standard CRI (80+).
- 347V cannot work with Emergency Battery Backup.
- Not available with 2ft configuration due to space limitations.
- Certain restrictions apply such as wattage and length, please consult with the factory.
- Automatic on/off is not available. For automatic on/off, additional occupancy sensor is required or a manual on/off switch can be done.
- Available with C9(90 CRI) only.

RONDO2

Rotational LED

RONDO2-2-18L

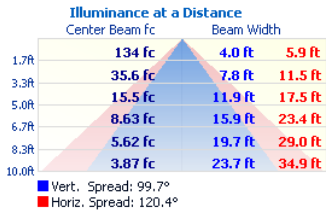

RONDO2-2-27L

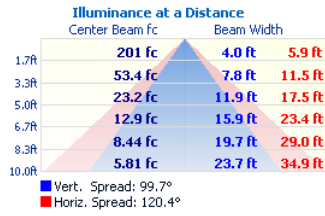

RONDO2-2-36L

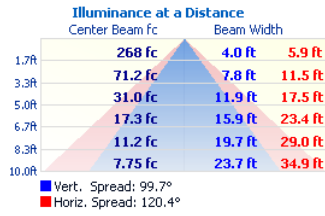

RONDO2-2-48L

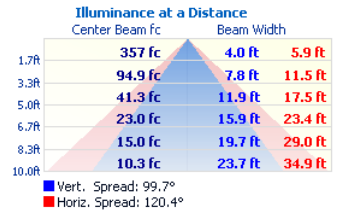

RONDO2-2-54L

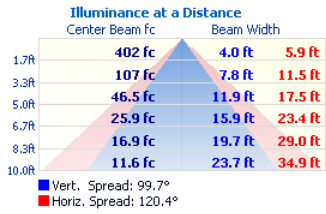

RONDO2-3-18L

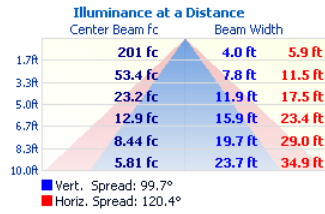

RONDO2-3-27L

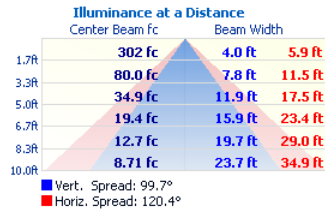

RONDO2-3-36L

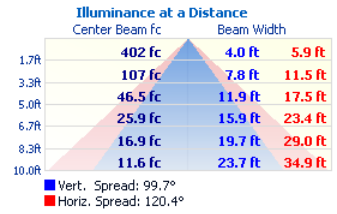

RONDO2-3-48L

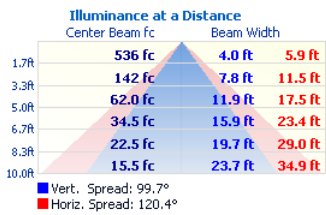

RONDO2-3-54L

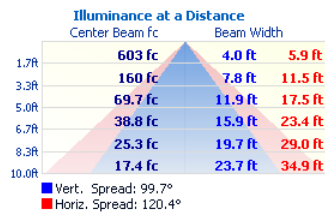

RONDO2-4-18L

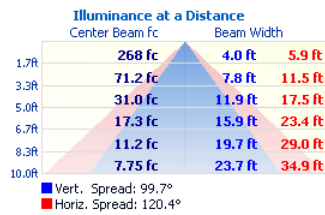

RONDO2-4-27L

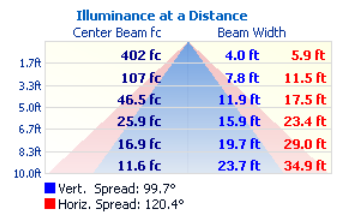

RONDO2-4-36L

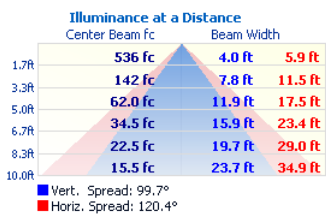

RONDO2-4-48L

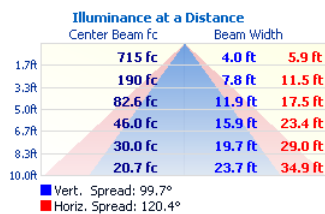

RONDO2-4-54L

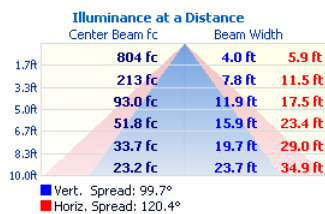

RONDO2-8-18L

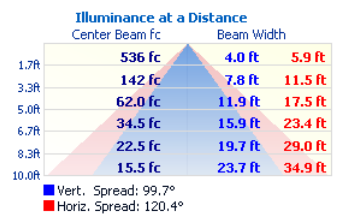

RONDO2-8-27L

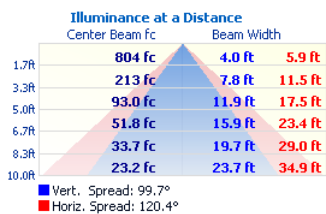

RONDO2-8-36L

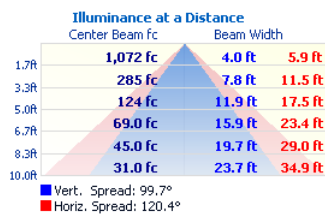

RONDO2-8-48L

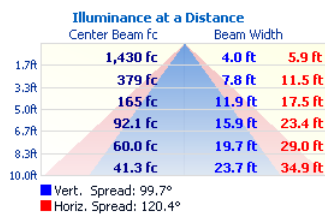

RONDO2-8-54L

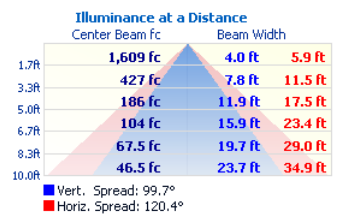

RONDO2

*Fixture can be customized: angle 45°, 90°, 135°, 180° (up light).
 *Field adjustable using allen key (provided).

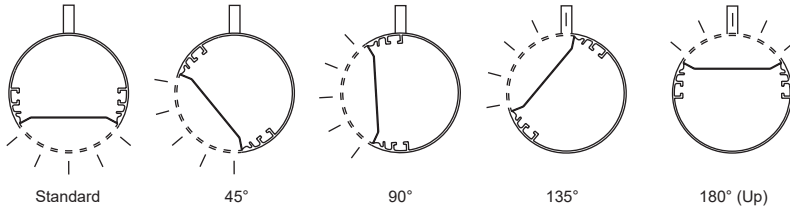

WALL MOUNT

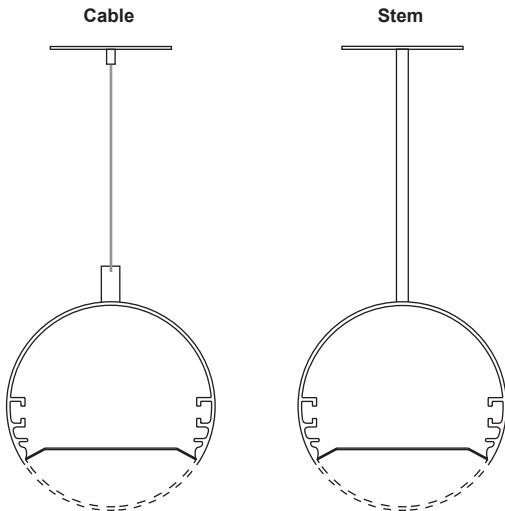

*Compatible with 1/2" pipe stem (provided by others).

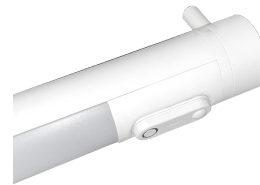

Lutron Vive Integral
 fixture control installation

WEIGHT

Item	lbs	kg
RONDO2-2	5.08	2.3
RONDO2-3	6.01	2.72
RONDO2-4	6.76	3.06
RONDO2-8	10.88	4.93

RONDO2

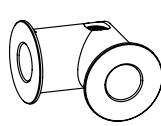
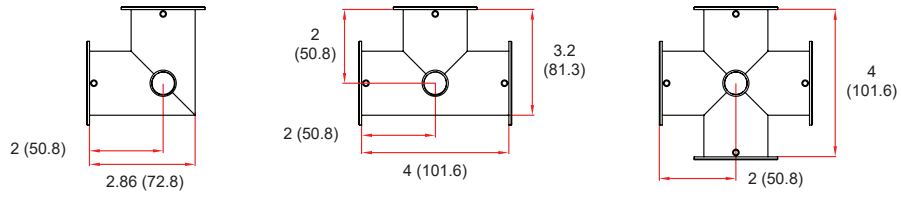

LC

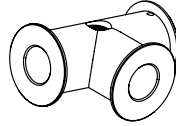

TC

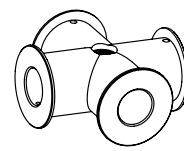

XC

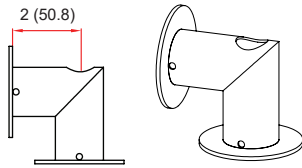

LC-VD

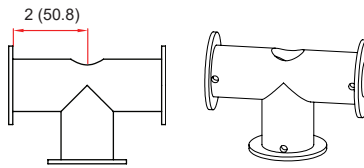

TC-VD

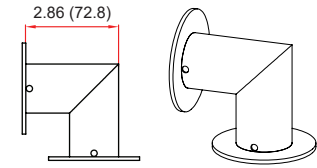

LC-BT

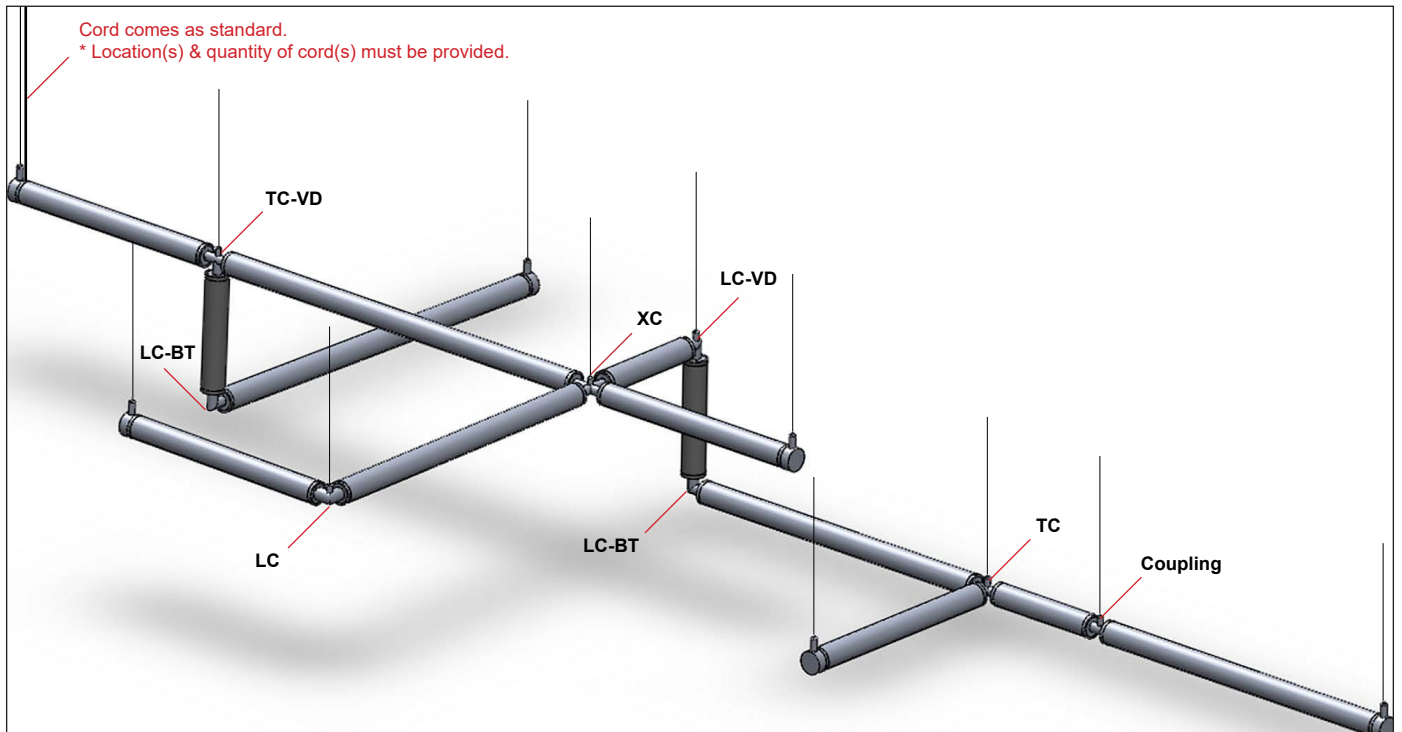

RONDO2

Rotational LED

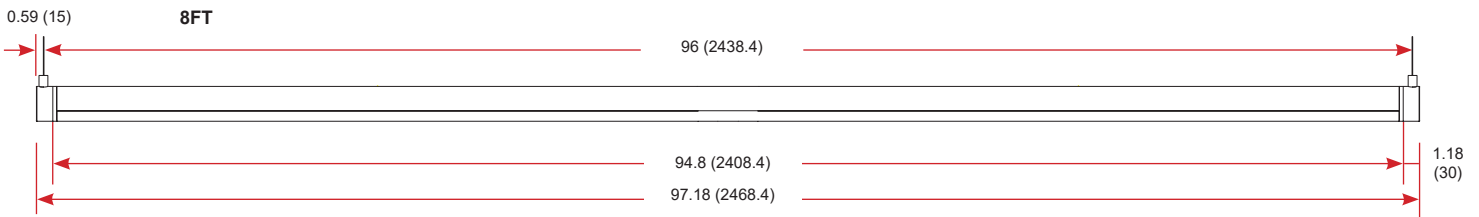
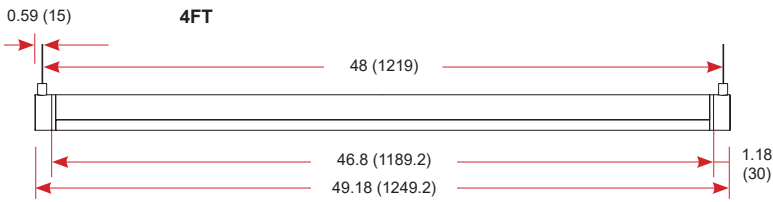
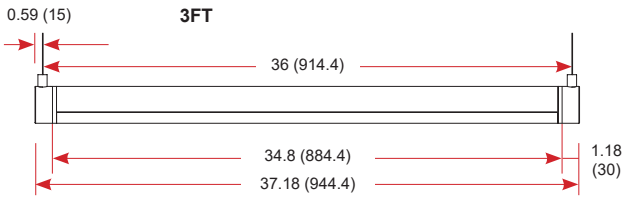
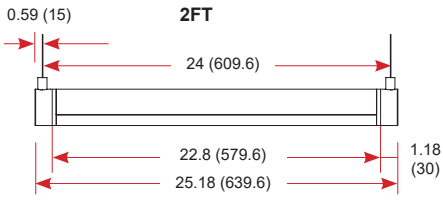

All dimensions are in inches (millimeters).

Coupling

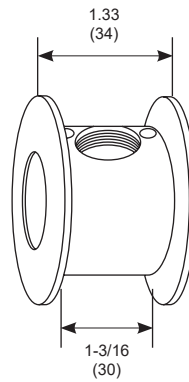

Coupling for continuous run

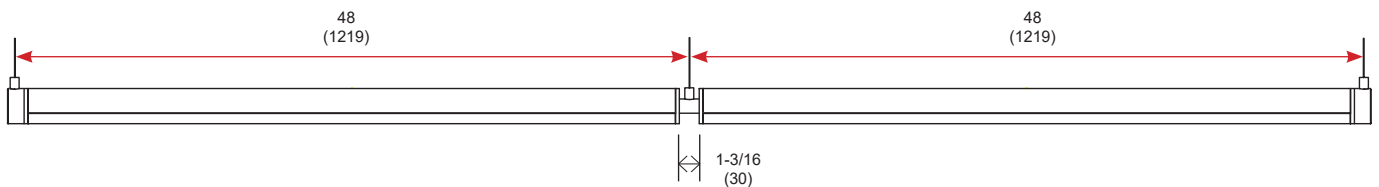

Total run = 97.05 (2465)
 Calculation: (1245-30)x2+30 = 2460
 * Recommended to calculate in mm. for precised measurement.

COMPATIBLE DIMMER SWITCH (TABLE 1)

Model #	Brand	Compatible Dimmer Switch	
(Blank)	-	<Leviton>	IllumaTech IP7 series
		<Lutron>	Visit www.lutron.com/advance for a list of dimmers (Mark VII) that will work with this driver.
		<Philips>	Sunrise : SR1200ZTUNV
ES566	eldoLED SOLOdrive	<Busch-Jaeger>	2112U-101
		<Jung>	240-10
		<Leviton>	IllumaTech - IP710-DLX
		<Lightoller Controls>	ZP600FAM120
		<Merten>	5729
		<Pass & Seymour>	CD4FB-W
		<Wattstopper>	DCLV1
		<Sensor Switch>	nIO EZ
		<Synergy>	ISD BC
		<ABB>	SD/S 2.16.1
		<Lutron>	Nova T: NTFTV Diva - DVTv-xx, NFTV GRAFIK Eye: GRX-TVI w GRX3503 Energy Savr Node: QSN-4T16-S TVM2 Module
		<Crestron>	GLX-DIMFLV8, GLXP-DIMFLV8, GLPAC-DIMFLV4-*, GLPAC-DIMFLVV8-*, GLPP-DIMFLVEX-PM, GLPP-1DIMFLV2EX-PM, GLPP-1DIMFLV3EX-PM, DIN-AO8, DIN-4DIMFLV4, CLS-EXP-DIMFLV, CLCI-1DIMFLV2EX
LDE1	Lutron Hi-lume 1% EcoSystem	<Lutron>	PowPak Dimming Modules: RMJ-ECO32-DV-B, FCJ/FCJS-ECO 1,2 Energi Savr Node (120V only): QSN-1ECO-S, QSN-2ECO-S GRAFIK Eye QS/Homeworks QS control unit (120V only): QSGRJ- E(wireless) QSGR- _E Quantum Hub (120V only): QP2- _2C/4C/6C/8C Homeworks QS/myRoom Plus power module (120V only): LQSE-2ECO-D
PHSR 3	Philips Xitanium Sensor-Ready	<Illumra>	<u>Single Rocker Self-Powered Light Switch (on/off, dim-up/down)</u> Illumra# ZBT-S1AWH Digi-Key# 1082-1033-ND <u>Dual Rocker Self-Powered Light Switch (on/off, dim-up/down, scene1,2)</u> Illumra# ZBT-S2AWH Digi-Key# 1082-1034-ND
TDM	KEYSTONE	<Lutron>	Diva DV-600P, SkyLark S-600P, Ariadni AY-600P, Ariadni TG-603P, Maestro MA-600 (Digital), Diva CFL/LED DVCL-153P, Satin Colors DVSC-600P-SW
		<Leviton>	6641, IllumaTech IPI06-1LX, ToggleTouch TGI06-1LW (Digital)
ELV	KEYSTONE	<Lutron>	MAELV-600BL (Digital), DVELV-300P, SkyLark SELV-300P
LTEA2W	Lutron Hi-lume 2-wire (120V forward voltage only)	<Lutron>	Visit http://www.lutron.com/TechnicalDocumentLibrary/369543_ENG.pdf for a list of compatible dimmer switches.

NOTES:

- All devices connected to one FCJ/FCJS-ECO will be controlled together. Devices will dim to the same level as the result of a control command. For more detail on adjusting low-end light level refer to Application Note#556 at www.lutron.com.
- For the Line/Hot (L/H) terminal on the driver, it is preferred not to use the switched hot (red) wire from the control but rather the hot wire directly from the power source.
- Recommended for EasySense System.

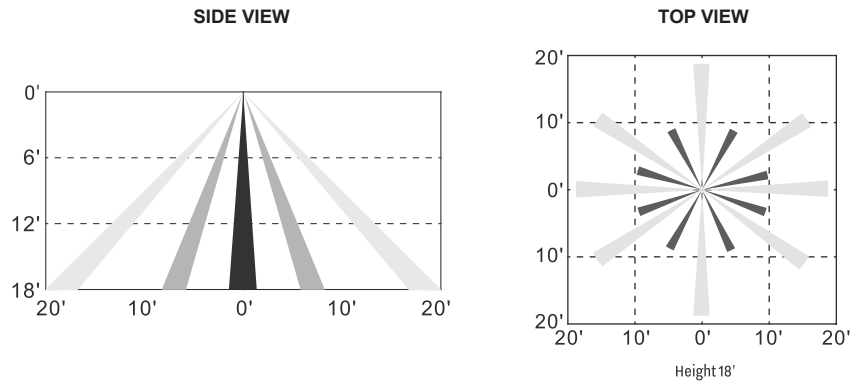

AMS, IFS105SE coverage pattern

RONDO2

RONDO2-SQ examples (Measurement from center point)

2'4"-2'4" (Minimum)

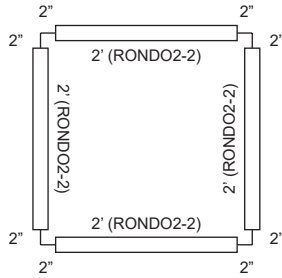

10'5.2"-2'4" (Minimum)

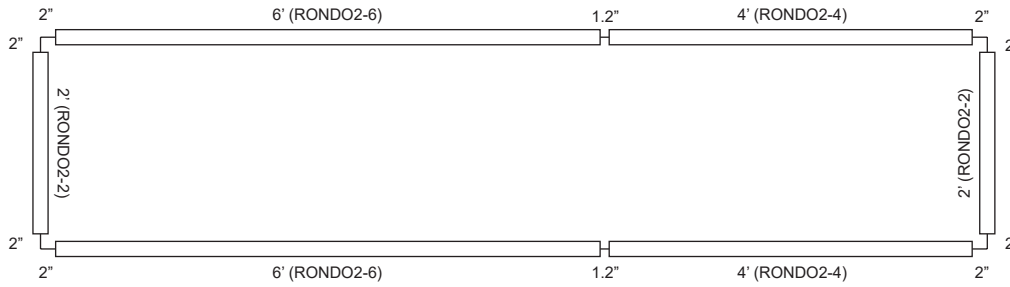

RONDO2-CM examples (Measurement from center point)

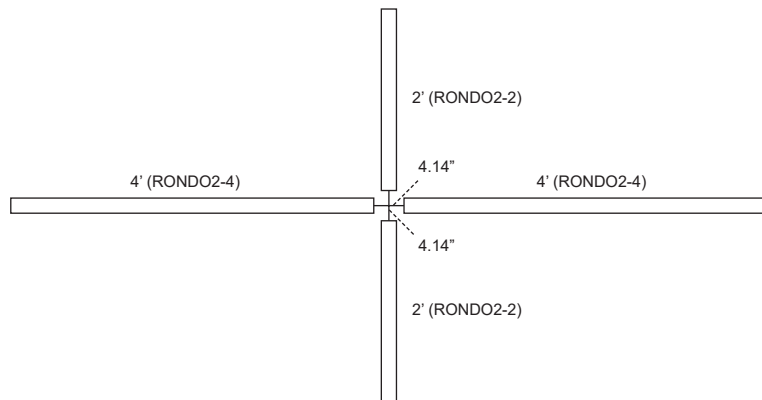
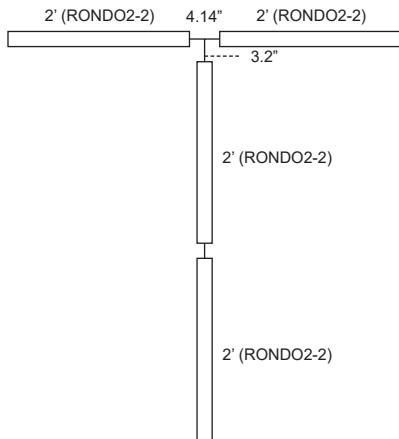

ARCHITECTURAL LINEAR

RONDO2 NON-LIT CONNECTOR PATTERNS

Instruction:

- Provide sketches illustrating corner types and overall dimensions.
- Must provide the power location in the drawing.
- Utopia Lighting will decide the optimal fixture combination unless otherwise specified in the drawing

