

# SS LED

Project Name:	
Type:	



Square

Round

NLE



**APPLICATION**

The LED slim strip light series are more efficient and compact. The LED technology used illuminates a crisper brightness while saving more energy to that of the traditional lights. Its functionality makes it a standard fixture used in storage areas, displays, institutions, industrial and retail applications.

**FEATURES:**

- Die-formed steel channel with knock-outs for versatile configuration and simple mounting.
- Available with 1 or 2 rows of LED, and in single unit lengths or as tandems.
- One continuous lens for 8-foot fixtures.
- Finish is high-gloss baked white enamel over rust inhibiting phosphate coating for maximum corrosion resistance.
- 11.9% uplight (RF lens), 13.4% uplight (SF lens).
- Paint after fabrication.

**MOUNTING:**

- Fixture is wall mounted (Not available with sensor option), surface mounted, or suspended mounted with chains, stems or cables.
- Joiner clip provided for easy continuous run (with "CON" option).
- Metal belly band provided to eliminate light leak from space between lenses in continuous run (with "CON" option).
- Rotatable mounting bracket is optional.
- Compatible with most ceiling types.

**LED:**

- High quality array LEDs.
- LM80
- Color Temperature: 2700/3000/3500/4000/5000 (K)
- Color Rendering Index: > 82.8
- Calculated L70: 122,000 hours
- Reported L70: +60,000 hours

**ELECTRICAL:**

- High power factor electronic driver, operate from a 120 ~ 277 Vac input range, 50 / 60 Hz.
- Features included over voltage protection, surge, short circuit protection and over load protection.
- Power Factor: typical > 0.95, THD <20, meets Class1 or Class2 circuit.
- Philips Xitanium: 0-10V Dim to 1%(PH).
- Osram Optotronic: 0-10V Dim to 1%(OS1) or 10%(OS).
- Generic : 0-10V 10% dim. (GR)
- Minimum starting temperature: -4°F (-20°C) ~ 122°F (50°C).
- <ELCU-200>
- Guarantees emergency lighting remains ON or is turned on when power to the control device is lost.
- Interfaces with fire alarm panel or security system.
- "Watchdog" feature allows emergency loads to be controlled in tandem with normal power loads.
- UL listed for use in emergency circuits.

**LISTING:**

- UL/CUL listed and labeled.
- Listed to UL 1598 and UL 8750.
- DLC listed. <sup>6</sup>
- Suitable for damp locations.
- CEC Compliant EM (please contact for more information)
- ARRA compliant (optional).
- BAA compliant (optional).
- 5 years warranty.
- 7 or 10 years limited warranty. (optional) <sup>5</sup>
- Bluetooth Mesh System available, please contact factory for more information.

# SS LED

## CONFIGURATIONS

Series	Size	Model #	AC Input	Lens	Lumen Output (3000K)	Lumen Efficiency (3000K)	lm Lumen Output (3500K)	Lumen Efficiency (3500K)	Lumen Output (4000K)	Lumen Efficiency (4000K)	Lumen Output (5000K)	Lumen Efficiency (5000K)
SS	2FT	L18	19.2W	SC	2470.89 lm	130.58 lm/W	2525.06 lm	131.51 lm/W	2553.43 lm	130.58 lm/W	2579.22 lm	134.33 lm/W
				SF	2330.81 lm	123.18 lm/W	2381.91 lm	124.06 lm/W	2408.67 lm	123.18 lm/W	2433 lm	126.72 lm/W
				RC	2514.48 lm	132.88 lm/W	2569.60 lm	133.83 lm/W	2598.47 lm	132.88 lm/W	2624.72 lm	136.70 lm/W
				RF	2336.50 lm	123.48 lm/W	2387.72 lm	124.36 lm/W	2414.55 lm	123.48 lm/W	2438.94 lm	127.03 lm/W
		NLE	2589.91 lm	134.89 lm/W	2646.68 lm	137.84 lm/W	2676.42 lm	139.39 lm/W	2703.46 lm	140.80 lm/W		
		L27	29.7W	SC	3873.47 lm	130.42 lm/W	3958.41 lm	133.28 lm/W	4002.9 lm	134.78 lm/W	4178.49 lm	140.69 lm/W
				SF	3653.9 lm	123.03 lm/W	3733.88 lm	125.72 lm/W	3776.05 lm	127.14 lm/W	3941.48 lm	132.71 lm/W
				RC	3941.78 lm	132.72 lm/W	4028.21 lm	135.63 lm/W	4073.35 lm	137.15 lm/W	4252.14 lm	143.17 lm/W
				RF	3662.9 lm	123.33 lm/W	3743.09 lm	126.03 lm/W	3785.26 lm	127.45 lm/W	3950.99 lm	133.03 lm/W
		NLE	4060.03 lm	136.70 lm/W	4149.05 lm	139.69 lm/W	4195.55 lm	141.26 lm/W	4379.70 lm	147.46 lm/W		
		L36	37.26W	SC	4859.50 lm	130.42 lm/W	4966.02 lm	133.28 lm/W	5021.81 lm	134.78 lm/W	5241.96 lm	140.69 lm/W
				SF	4584 lm	123.03 lm/W	4684.48 lm	125.72 lm/W	4737.11 lm	127.14 lm/W	4944.78 lm	132.71 lm/W
	RC			4945.22 lm	132.72 lm/W	5053.62 lm	135.63 lm/W	5110.39 lm	137.15 lm/W	5334.43 lm	143.17 lm/W	
	RF			4595.18 lm	123.33 lm/W	4695.91 lm	126.03 lm/W	4748.67 lm	127.45 lm/W	4956.85 lm	133.03 lm/W	
	NLE	5093.57 lm	136.70 lm/W	5205.22 lm	139.70 lm/W	5263.70 lm	141.27 lm/W	5494.46 lm	147.46 lm/W			
	3FT	L13	14.85W	SC	1907.18 lm	128.43 lm/W	1955.3 lm	131.67 lm/W	1979.35 lm	133.29 lm/W	2003.26 lm	134.9 lm/W
				SF	1799 lm	121.15 lm/W	1844.37 lm	124.2 lm/W	1867.1 lm	125.73 lm/W	1889.8 lm	127.26 lm/W
				RC	1940.74 lm	130.69 lm/W	1989.75 lm	133.99 lm/W	2014.25 lm	135.64 lm/W	2038.6 lm	137.28 lm/W
				RF	1803.38 lm	121.44 lm/W	1848.97 lm	124.51 lm/W	1871.7 lm	126.04 lm/W	1894.4 lm	127.57 lm/W
		NLE	1998.95 lm	134.61 lm/W	2049.3 lm	138 lm/W	2074.54 lm	139.7 lm/W	2099.8 lm	141.4 lm/W		
		L20	22W	SC	2801 lm	127.32 lm/W	3073.4 lm	130.53 lm/W	2906.86 lm	132.13 lm/W	2942.28 lm	133.74 lm/W
				SF	2642.2 lm	120.1 lm/W	2708.86 lm	123.13 lm/W	2742 lm	124.64 lm/W	2775.3 lm	126.15 lm/W
				RC	2850.32 lm	129.56 lm/W	2922.26 lm	132.83 lm/W	2958 lm	134.46 lm/W	2994 lm	139.09 lm/W
				RF	2648.58 lm	120.39 lm/W	2715.46 lm	123.43 lm/W	2748.68 lm	124.94 lm/W	2782.12 lm	126.46 lm/W
		NLE	2935.68 lm	133.44 lm/W	3009.8 lm	136.81 lm/W	3046.78 lm	138.49 lm/W	3083.74 lm	140.17 lm/W		
		L27	29.7W	SC	3814.37 lm	128.43 lm/W	3910.6 lm	131.37 lm/W	3958.7 lm	133.29 lm/W	4006.53 lm	134.9 lm/W
				SF	3598.15 lm	131.15 lm/W	3688.74 lm	124.2 lm/W	3734.2 lm	125.73 lm/W	3779.6 lm	127.26 lm/W
	RC			3881.5 lm	130.69 lm/W	3979.5 lm	133.99 lm/W	4028.5 lm	135.64 lm/W	4077.2 lm	137.28 lm/W	
	RF			3606.76 lm	121.44 lm/W	3697.9 lm	124.51 lm/W	3743.38 lm	126.04 lm/W	3788.8 lm	127.57 lm/W	
	NLE	3998 lm	134.61 lm/W	4098.6 lm	138 lm/W	4149 lm	139.7 lm/W	4199.58 lm	141.4 lm/W			
	L40	44.55W	SC	5734.47 lm	128.72 lm/W	5879.26 lm	131.97 lm/W	5951.43 lm	133.59 lm/W	6023.6 lm	135.21 lm/W	
			SF	5409.26 lm	121.42 lm/W	5545.58 lm	124.48 lm/W	5613.74 lm	126.01 lm/W	5682.35 lm	127.55 lm/W	
			RC	5835.6 lm	130.99 lm/W	5982.62 lm	134.29 lm/W	6056.12 lm	135.94 lm/W	6130 lm	137.6 lm/W	
			RF	5422.6 lm	121.72 lm/W	5559.4 lm	124.79 lm/W	5627.55 lm	126.32 lm/W	5696.16 lm	127.86 lm/W	
	NLE	6010.68 lm	134.92 lm/W	6162.15 lm	138.32 lm/W	6237.9 lm	140.02 lm/W	6313.62 lm	141.75 lm/W			
	L54	59.4W	SC	7645.37 lm	128.71 lm/W	7838.4 lm	131.96 lm/W	7934.65 lm	133.58 lm/W	8028.5 lm	135.16 lm/W	
			SF	7212.34 lm	121.42 lm/W	7394.1 lm	124.48 lm/W	7485 lm	126.01 lm/W	7576.47 lm	127.55 lm/W	
			RC	7780.2 lm	130.98 lm/W	7976.8 lm	134.29 lm/W	8074.8 lm	135.94 lm/W	8170.47 lm	137.55 lm/W	
			RF	7229.57 lm	121.71 lm/W	7411.9 lm	124.78 lm/W	7503.4 lm	126.32 lm/W	7591.9 lm	127.81 lm/W	
	NLE	8013.65 lm	134.91 lm/W	8430.6 lm	141.93 lm/W	8534 lm	143.67 lm/W	8634.9 lm	145.37 lm/W			

# SS LED

## CONFIGURATIONS

Series	Size	Model #	AC Input	Lens	Lumen Output (3000K)	Lumen Efficiency (3000K)	Lumen Output (3500K)	Lumen Efficiency (3500K)	Lumen Output (4000K)	Lumen Efficiency (4000K)	Lumen Output (5000K)	Lumen Efficiency (5000K)
SS	4FT	L27	29.9W	SC	3806.76 lm	127.32 lm/W	3902.73 lm	130.53 lm/W	3950.72 lm	132.13 lm/W	3998.7 lm	133.74 lm/W
				SF	3590.94 lm	120.10 lm/W	3681.47 lm	123.13 lm/W	3726.74 lm	124.64 lm/W	3772 lm	126.15 lm/W
				RC	3873.91 lm	129.56 lm/W	3971.57 lm	132.83 lm/W	4020.41 lm	134.46 lm/W	4069.23 lm	136.09 lm/W
				RF	3599.70 lm	120.39 lm/W	3690.45 lm	123.43 lm/W	3735.83 lm	124.94 lm/W	3781.20 lm	126.46 lm/W
				NLE	3990.12 lm	133.44 lm/W	4090.71 lm	136.81 lm/W	4141.02 lm	138.49 lm/W	4191.30 lm	140.17 lm/W
		L36	39.33W	SC	5051.12 lm	128.43 lm/W	5178.46 lm	131.67 lm/W	5242.13 lm	133.29 lm/W	5305.80 lm	134.90 lm/W
				SF	4764.76 lm	121.15 lm/W	4884.88 lm	124.20 lm/W	4944.94 lm	125.73 lm/W	5005 lm	127.26 lm/W
				RC	5140.22 lm	130.69 lm/W	5269.81 lm	133.99 lm/W	5334.60 lm	135.64 lm/W	5399.39 lm	137.28 lm/W
				RF	4776.39 lm	121.44 lm/W	4896.80 lm	124.51 lm/W	4957.01 lm	126.04 lm/W	5017.21 lm	127.57 lm/W
				NLE	5294.42 lm	134.61 lm/W	5427.90 lm	138 lm/W	5494.63 lm	139.70 lm/W	5561.37 lm	141.40 lm/W
		L54	57.36W	SC	7383.42 lm	128.72 lm/W	7569.56 lm	131.97 lm/W	7662.63 lm	133.59 lm/W	7756.69 lm	135.21 lm/W
				SF	6964.83 lm	121.42 lm/W	7140.42 lm	124.48 lm/W	7228.21 lm	126.01 lm/W	7316 lm	127.55 lm/W
				RC	7513.66 lm	130.99 lm/W	7703.09 lm	134.29 lm/W	7797.79 lm	135.94 lm/W	7892.50 lm	137.60 lm/W
				RF	6981.82 lm	121.72 lm/W	7157.84 lm	124.79 lm/W	7245.85 lm	126.32 lm/W	7333.85 lm	127.86 lm/W
				NLE	7739.06 lm	134.92 lm/W	7934.18 lm	138.32 lm/W	8031.72 lm	140.02 lm/W	8129.27 lm	141.72 lm/W
		L72	76.48W	SC	9844.30 lm	128.71 lm/W	10356.32 lm	131.96 lm/W	10483.60 lm	133.58 lm/W	10607.57 lm	135.16 lm/W
				SF	9286.20 lm	121.42 lm/W	9769.19 lm	124.48 lm/W	9889.26 lm	126.01 lm/W	10006.20 lm	127.55 lm/W
				RC	10017.95 lm	130.98 lm/W	10539 lm	134.29 lm/W	10668.53 lm	135.94 lm/W	10794.69 lm	137.55 lm/W
				RF	9308.85 lm	121.71 lm/W	9793.03 lm	124.78 lm/W	9913.39 lm	126.32 lm/W	10030.62 lm	127.81 lm/W
				NLE	10318.48 lm	134.91 lm/W	10855.17 lm	141.93 lm/W	10988.58 lm	143.67 lm/W	11118.53 lm	145.37 lm/W
	8FT	L27	29.9W	SC	4069.09 lm	136.09 lm/W	4162.67 lm	139.22 lm/W	4213.80 lm	140.93 lm/W	4260.75 lm	142.50 lm/W
				SF	3838.26 lm	128.37 lm/W	3926.76 lm	131.33 lm/W	3974.90 lm	132.94 lm/W	4019.15 lm	134.42 lm/W
				RC	4140.85 lm	138.49 lm/W	4236.23 lm	141.68 lm/W	4288.25 lm	143.42 lm/W	4336.09 lm	145.02 lm/W
				RF	3847.83 lm	128.69 lm/W	3936.33 lm	131.65 lm/W	3984.77 lm	133.27 lm/W	4029.02 lm	134.75 lm/W
				NLE	4265.07 lm	142.64 lm/W	4363.31 lm	145.93 lm/W	4416.89 lm	147.72 lm/W	4466.17 lm	149.37 lm/W
		L36	39.33W	SC	5352.42 lm	136.09 lm/W	5475.52 lm	139.22 lm/W	5542.77 lm	140.93 lm/W	5604.52 lm	142.50 lm/W
				SF	5048.79 lm	128.37 lm/W	5165.20 lm	131.33 lm/W	5228.53 lm	132.94 lm/W	5286.73 lm	134.42 lm/W
				RC	5446.81 lm	138.49 lm/W	5572.27 lm	141.68 lm/W	5640.70 lm	143.42 lm/W	5703.63 lm	145.02 lm/W
				RF	5061.37 lm	128.69 lm/W	5177.79 lm	131.65 lm/W	5241.50 lm	133.27 lm/W	5299.71 lm	134.75 lm/W
				NLE	5610.21 lm	142.64 lm/W	5739.43 lm	145.93 lm/W	5809.92 lm	147.72 lm/W	5874.73 lm	149.37 lm/W
		L54	57.81W	SC	7867.33 lm	136.09 lm/W	8048.57 lm	139.22 lm/W	8147.42 lm	140.93 lm/W	8238.04 lm	142.50 lm/W
				SF	7421.31 lm	128.37 lm/W	7592.27 lm	131.33 lm/W	7685.52 lm	132.94 lm/W	7771 lm	134.42 lm/W
				RC	8006.11 lm	138.49 lm/W	8190.54 lm	141.68 lm/W	8291.14 lm	143.42 lm/W	8383.35 lm	145.02 lm/W
				RF	7439.42 lm	128.69 lm/W	7610.80 lm	131.65 lm/W	7704.27 lm	133.27 lm/W	7789.96 lm	134.75 lm/W
				NLE	8246.30 lm	142.64 lm/W	8436.25 lm	145.93 lm/W	8539.87 lm	147.72 lm/W	8634.85 lm	149.36 lm/W
		L72	78.2W	SC	10518.79 lm	134.51 lm/W	10761.11 lm	137.61 lm/W	10893.28 lm	139.30 lm/W	11014.44 lm	140.85 lm/W
				SF	9922.45 lm	126.89 lm/W	10151.03 lm	129.81 lm/W	10275.71 lm	131.40 lm/W	10390 lm	132.86 lm/W
				RC	10704.34 lm	136.88 lm/W	10950.93 lm	140.04 lm/W	11085.44 lm	141.76 lm/W	11208.73 lm	143.33 lm/W
				RF	9946.66 lm	127.20 lm/W	10175.80 lm	130.13 lm/W	10300.78 lm	131.72 lm/W	10415.35 lm	133.19 lm/W
				NLE	11025.47 lm	141 lm/W	11279.45 lm	144.23 lm/W	11418 lm	146.01 lm/W	11545 lm	147.63 lm/W
	L108	105.4W	SC	14203.91 lm	134.76 lm/W	14531.12 lm	137.87 lm/W	14709.60 lm	139.56 lm/W	14873.20 lm	141.11 lm/W	
			SF	13398.65 lm	127.12 lm/W	13707.31 lm	130.05 lm/W	13875.67 lm	131.65 lm/W	14030 lm	133.11 lm/W	
			RC	14454.46 lm	137.14 lm/W	14787.45 lm	140.30 lm/W	14969.07 lm	142.02 lm/W	15135.56 lm	143.60 lm/W	
			RF	13431.34 lm	127.43 lm/W	13740.76 lm	130.37 lm/W	13909.53 lm	131.97 lm/W	14064.23 lm	133.44 lm/W	
			NLE	14888.09 lm	141.25 lm/W	15231.07 lm	144.50 lm/W	15418.14 lm	146.28 lm/W	15589.62 lm	147.90 lm/W	
	L144	140.53W	SC	18937.81 lm	134.76 lm/W	19374.30 lm	137.87 lm/W	19612.67 lm	139.56 lm/W	19828.68 lm	141.10 lm/W	
			SF	17864.17 lm	127.12 lm/W	18275.92 lm	130.05 lm/W	18500.77 lm	131.65 lm/W	18704.54 lm	133.11 lm/W	
			RC	19271.87 lm	137.14 lm/W	19716.06 lm	140.30 lm/W	19958.63 lm	142.02 lm/W	20178.46 lm	143.59 lm/W	
			RF	17907.76 lm	127.43 lm/W	18320.51 lm	130.37 lm/W	18545.91 lm	131.97 lm/W	18750.18 lm	133.42 lm/W	
			NLE	19850.02 lm	141.25 lm/W	20307.54 lm	144.50 lm/W	20557.38 lm	146.28 lm/W	20783.81 lm	147.89 lm/W	

# SS LED

ORDERING INFORMATION

EXAMPLE: SS-4-L36-40K-SC-UNV

MODEL	LENGTH		LED	COLOR TEMP.	EFFICACY
SS	2	2' Length <sup>8</sup>	<b>(Blank)</b> Wiring for Individual mount (Std.)  <b>CON (a total watt should be per 4ft)</b> Wiring for Continuous mount (Specify row/length and number of power feed)	<b>-27K</b> 2700K <sup>10</sup> <b>-30K</b> 3000K <b>-35K</b> 3500K <b>-40K</b> 4000K (Std.) <b>-50K</b> 5000K	<b>(Blank)</b> <b>HE</b> Standard High Efficacy 
	3	3' Length			
	4	4' Length			
	8	8' Length <sup>1</sup>			
<p>* Number of circuit(s) should be determined by the customer prior to ordering the continuous run considering the AC input voltage and total run wattage.</p>					
<p>* Contact factory for custom wattage or lumen requirement.<sup>3</sup></p>					

CRI	DIFFUSER	VOLTAGE	MOUNTING
<b>(Blank)</b> <b>C9</b> 80+ CRI 90+ CRI <sup>11</sup>	<b>SC</b> Square - Clear Acrylic Lens <b>SF</b> Square - Frosted Acrylic Lens <b>RC</b> Round - Clear Acrylic Lens <b>RF</b> Round - Frosted Acrylic Lens <b>NLE</b> Non Lens option <b>NLEW</b> Non-Lens with Wall Wash optic <sup>22</sup>	<b>UNV</b> 120-277V (Std.) <b>120</b> 120V <b>277</b> 277V <b>347</b> 347V <b>480</b> 480V	<b>(Blank)</b> Ceiling Mount <b>VH</b> V-Hook <b>CHxx</b> Chain for use with V-hook (xx=length) <b>ACxx</b> Adjustable Aircraft Cable w/ Canopy and Cord (* xx = Specify length (48 or 96)) <b>YCxx</b> Adjustable Aircraft Y-cable with Toggles (* xx = Specify length in inches (60, 120, 180)) (Cord not included) <b>SH-3/8-xx</b> 3/8" IPS STEM w/ Canopy <b>SH-1/2-xx</b> 1/2" IPS STEM w/ Canopy (* xx = 18, 24, 36, 48 inches) <b>IDS</b> T-Bar Clip for Surface Mount <b>RB</b> Ceiling / Wall mount with rotatable bracket <b>CD</b> Conduit run

FIXTURE FINISH	CORD FINISH (for pendant)	CANOPY FINISH (for pendant)	CEILING TYPE (for pendant)	SUSPENSION LENGTH
<b>(Blank)</b> <b>*BK</b> Semi-Glossy White (Std.) <b>**CC</b> Black (RAL#9011) <b>*CC</b> Custom Color <sup>17</sup> <b>*AMB</b> Anti-Microbial Coating (Matte Skye White)	<b>(Blank)</b> White (Std.) <b>*BKC</b> Black	<b>(Blank)</b> White (Std.) <b>*BC</b> Black Canopy <b>*SC</b> Silver Canopy <b>**CSS</b> Custom Canopy Color (White is Std.)	<b>X1</b> 15/16" grid T-bar ceiling <b>X2</b> Hard ceiling <b>X3</b> Sloped Hard ceiling <b>X4</b> 9/16" T-bar ceiling	<b>AC48</b> Adjustable Aircraft Cable Canopy 48"L <b>AC96</b> Adjustable Aircraft Cable Canopy 96"L <b>ST24</b> Stem Canopy 24"L <b>ST48</b> Stem Canopy 48"L
<p>* Non-standard finish with extra charge.                      ** Additional charge &amp; set up fee.</p>				<p>* Contact factory for custom length.</p>

LED DRIVER		OPTIONS	
<b>GR</b>	Generic, 0-10V 10% dim (Std.) <sup>7</sup>	<b>WG</b>	Wireguard (White)
<b>DM1</b>	Generic 0-10V 1% dim	<b>EMG8</b>	1296 LUMEN EM Battery Backup (CEC Compliant EM) <sup>2, 8, 16</sup>
<b>PH</b>	Philips Xitanium, 0-10V 1% dim <sup>7</sup>	<b>EMG15</b>	2430 LUMEN EM Battery Backup (CEC Compliant EM) <sup>2, 8, 16</sup>
<b>OS</b>	Osram Optotronic, 0-10V 10% dim <sup>7</sup>	<b>EMG20</b>	3240 LUMEN EM Battery Backup (CEC Compliant EM) <sup>2, 8, 16</sup>
<b>OS1</b>	Osram Optotronic, 0-10V 1% dim <sup>7</sup>	<b>EMG25</b>	4050 LUMEN EM Battery Backup (CEC Compliant EM) <sup>2, 8, 16</sup>
<b>SD40</b>	40% / 100% Bi-Level Step dim (PH only)	<b>ELCU-200</b>	Fail-to-on Emergency lighting, UL924 <sup>9</sup>
<b>SDXX</b>	XX% / 100% Bi-Level Step dim (Specify XX : 10% ~ 70%) (PH only)	<b>GTD</b>	Bodine Generator Transfer Device
<b>TDM</b>	Triac Dim. (120V only)	<b>GTD10DIM</b>	Bodine Generator Transfer Device (0-10VDC Dimmer Override)
<b>TD30/70</b>	30% / 70% / 100% Tri-Level Step dim (PH only)	<b>DPMS</b>	Daylight Dimming Photosensor (0-10 VDC Control), (LSR-301-S required if FD-301 is installed) <sup>4, 20</sup>
<b>TDXX/YY</b>	XX% / YY% / 100% Tri-Level Step dim (Specify XX, YY : 10% ~ 70%) (PH only)	<b>AMS</b>	Bluetooth Mesh Wireless Sensor. Occupancy/Daylight/0-10V Dimming <sup>4</sup>
<b>EC</b>	eldoLED ECOdrive 0-10V natural dim to 1% (Hybrid HydraDrive)	<b>SO</b>	Dimming Wires connected to sensor only (available option on FS-205 non-Bluetooth AMS sensor only) <sup>18</sup>
<b>ES566</b>	eldoLED SOLOdrive Natural Dimming to dark, 0-10V, 100% ~ 0.1% dim	<b>LSR-301-S</b>	Setup Remote Control for DPMS (Required for DPMS)
<b>LDE1</b>	Hi-lume 1% EcoSystem LED driver with Soft-on, Fade-to-Black dimming technology, 100% ~ 1% dim	<b>LSR-301-P</b>	Occupant Remote Control for DPMS
<b>ELV</b>	ELV compatible (reverse-phase or trailing-edge), (120V only)	<b>ARRA</b>	Assembled in USA for Buy American Act
<b>PHSR</b>	Philips Xitanium Sensor-Ready, Dali 5%~100% dim	<b>BAA</b>	BAA(Buy American Act) and BABA(Build America Buy America) compliant
<b>PHDL</b>	Philips Xitanium DALI driver, Dim to 5%	<b>MS</b>	Motion Sensor
<b>TRIoT</b>	Tridonic IoT ready, 1-100% dim via Smart Module Interface (SMI), automated dimming/lighting controls via Enlighted Sensor Interface Driver prewired for non-dimming applications	<b>LOS-502S</b>	Fixture external mount, PIR Occupancy Sensor, no dimming support, 120/277V with standard cone shape lens (15ft) with 1.18" extension joint. Adjustable through a dip switch
<b>ND</b>	Driver prewired for non-dimming applications	<b>HC403</b>	Microwave bi-level Occupancy Sensor, adjustable via DIP switch <sup>21</sup>
<b>ED560</b>	eldoLED LightShape DALI dim to dark, 0.1% ~ 100%	<b>HRC-05</b>	Remote control for HC403 sensor
<b>DIMT</b>	Tri-mode dimming (Triac, ELV, 0-10V)	<b>O7W</b>	Optional 7 Years Limited Warranty <sup>5</sup>
<b>DMX</b>	DMX512 control system (Only available with RGB+W option)	<b>O10W</b>	Optional 10 Years Limited Warranty <sup>5</sup>
<b>DLM</b>	Wattstopper's DLM interface (Only available with RGB+W option)	<b>CC</b>	Custom Color Housing (Specify RAL#)
<b>LTEA2W</b>	Hi-lume 1% 2-wire LED driver (120V forward phase only)	<b>COC</b>	Separated EM feed for City of Chicago code compliance
 <b>BLT</b>	Bluetooth Mesh System (contact factory for more information)	<b>SYM</b>	Symmetric Reflector
		<b>ASY</b>	Asymmetric Reflector
		<b>JC4</b>	4" Octagon shape junction box cover plate

## LIGHTING CONTROL SYSTEM

<b>LUTRON VIVE</b>	<p>&lt;Lutron Vive System Enabled&gt;</p>  <a href="#">Click Here!</a>
<b>SNS200</b>	<EasySense>
<b>RS-IR</b>	EasySense Fixture-mount occupancy sensing, daylight harvesting and task tuning in one device (Must be ordered with PHSR driver) <sup>12, 15</sup>
<b>SU-5E-IoT</b>	IR dongle v2.0 for EasySense control
<b>SU-5E-CL</b>	<Enlighted>
<b>RS-WS</b>	Enlighted IoT-Ready Indoor Micro sensor with occupancy/vacancy detection, daylight harvesting, thermal sensing, task tuning, and room and zone control, Bluetooth enabled <sup>13, 19</sup>
<b>IFS105SE</b>	Enlighted Indoor Micro sensor with occupancy/vacancy detection, daylight harvesting, thermal sensing, task tuning, and room and zone control, Bluetooth enabled (Connected lighting sensor only)
<b>PPA102S</b>	Enlighted Room controller providing basic control functions of a standard wall switch with preset dimming capability
	<Bluetooth>
	Bluetooth Mesh Wireless Sensor. Occupancy/Daylight/0-10V Dimming
	Bluetooth Powerpack (Consult factory for installation location)

### NOTES:

- Tandem units.
- Contact factory for other emergency ballast options.
- Custom wattage products are not DLC qualified.
- Not available with Non Lens option (NLE).
- This limited warranty covers electrical parts only and does not apply to labor, equipment lease, or defect from improper installation or operation. (EM battery backup does not included)
- DesignLights Consortium® (DLC) qualified product. Not all versions of this product may be DLC qualified. Please check the DLC Qualified Products List at [www.designlights.org/QPL](http://www.designlights.org/QPL) to confirm which versions are qualified.
- To find an approved dimmer switch, please see table 1.
- For 2' length, only EMG8 available.
- Shipped separately.
- Available with C9 (90+ CRI) only.
- Lumen per watt is around 15% less than standard CRI (80+).
- See NFC and IR manual in the separate attachment. If your phone is not compatible, please order "RS-IR" and follow the manual.
- "RS-WS" option can be added if wish to have a wall switch, please see Enlighted Room Controller in the separate attachment.
- Must be ordered with either ED560 or MU050 driver.
- Refer to Advanced Grouping Datasheet for its default setting and compatible wireless switches.
- Emergency Ballast options are not available with 347V or 480V.
- Refer to color charts (RAL and/or Cardinal) in the separate attachment.
- Dimming wires provided and connected to sensor only, not for dimmer switch. (available with AMS and DPMS option)
- Must be ordered either with 0-10V LED driver or TRIOT (IoT-Ready LED driver).
- Automatic on/off is not available. For automatic on/off, additional occupancy sensor is required or a manual on/off switch can be done.
- See Table2 to find factory setting.
- Wall wash is available with NLE option only. (Available with up to 27W per 4ft section only)

### HC403 FACTORY SETTING (TABLE 2)

Detection Area	100%
Hold-time	5 sec
Daylight sensor	Disable
Stand-by period (tri-level control)	10 sec
Stand-by dimming level	10%

\* See a separate attachment to find more setting options.

# SS LED

SS-2-L18-SC

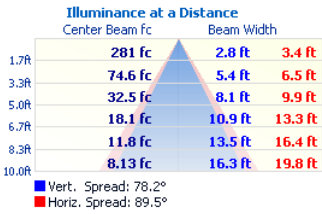

SS-2-L18-SF

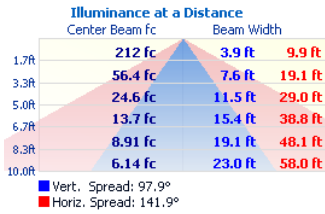

SS-2-L18-RC

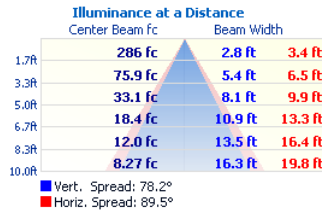

SS-2-L18-RF

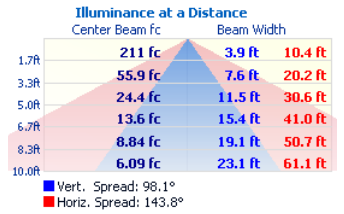

SS-2-L18-NLE

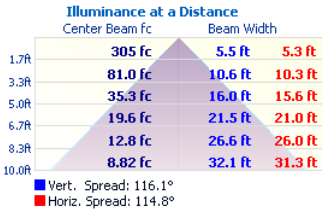

SS-2-L27-SC

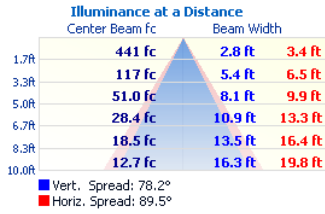

SS-2-L27-SF

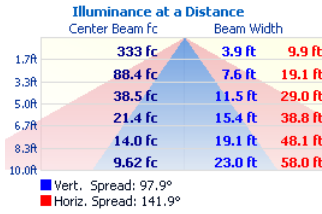

SS-2-L27-RC

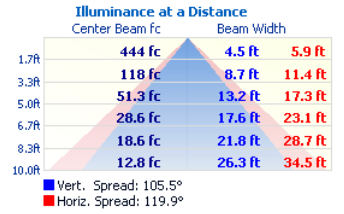

SS-2-L27-RF

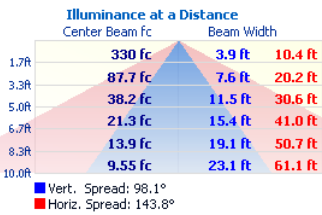

SS-2-L27-NLE

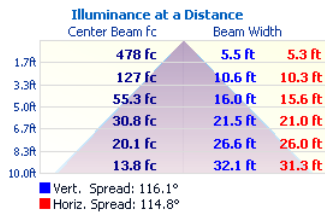

SS-2-L36-SC

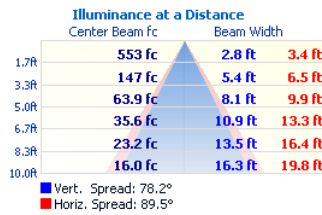

SS-2-L36-SF

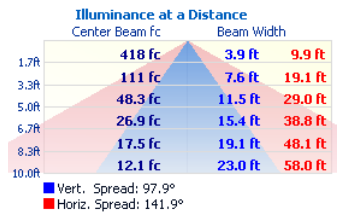

SS-2-L36-RC

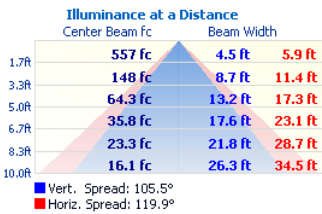

SS-2-L36-RF

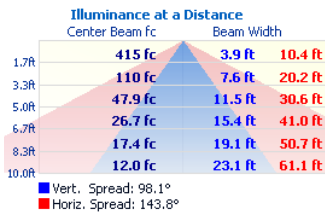

SS-2-L36-NLE

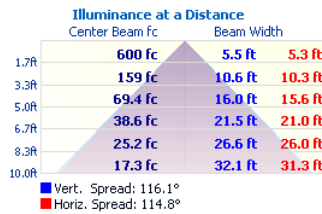

SS-3-L13-SC

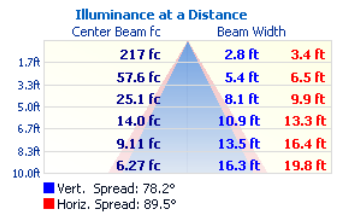

SS-3-L13-SF

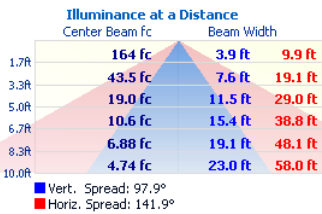

SS-3-L13-RC

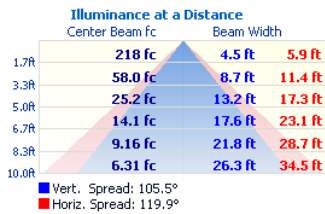

SS-3-L13-RF

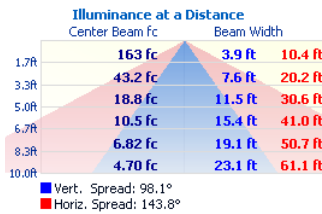

SS-3-L13-NLE

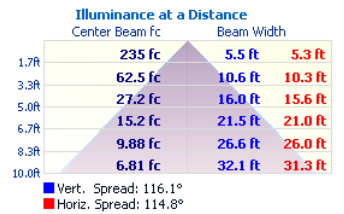

SS-3-L20-SC

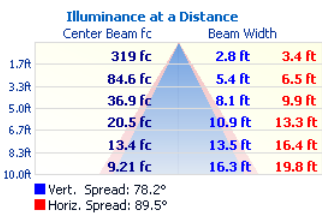

SS-3-L20-SF

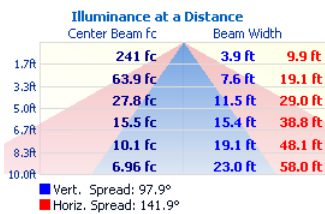

SS-3-L20-RC

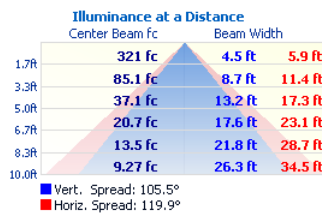

SS-3-L20-RF

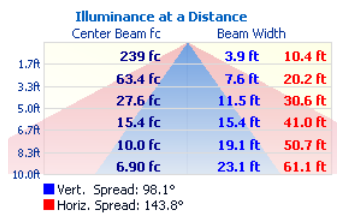

# SS LED

SS-3-L20-NLE

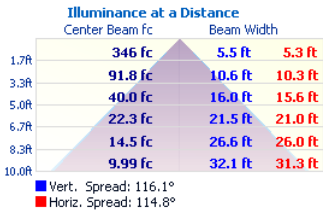

SS-3-L27-SC

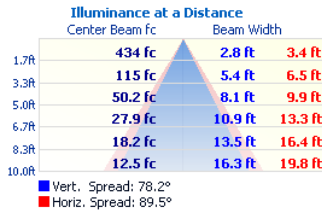

SS-3-L27-SF

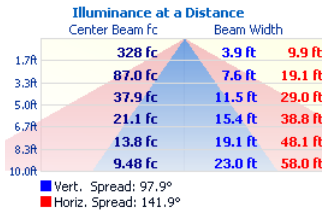

SS-3-L27-RC

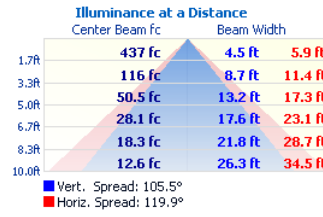

SS-3-L27-RF

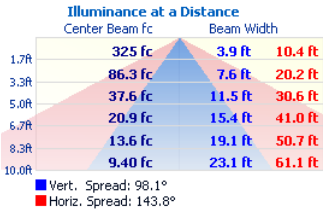

SS-3-L27-NLE

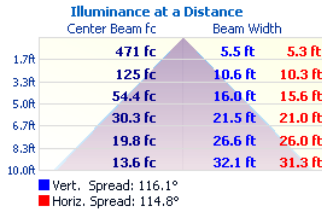

SS-3-L40-SC

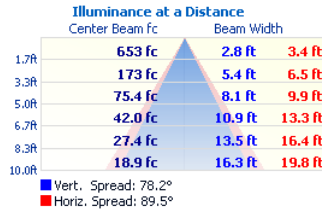

SS-3-L40-SF

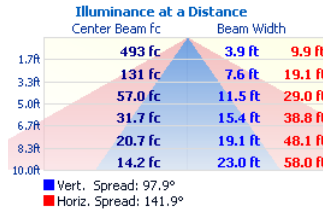

SS-3-L40-RC

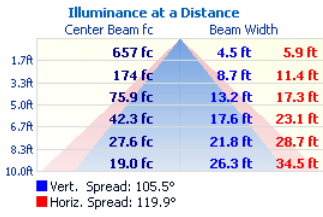

SS-3-L40-RF

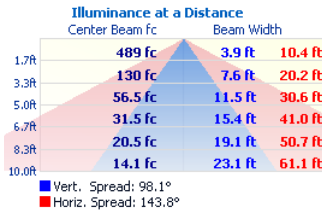

SS-3-L40-NLE

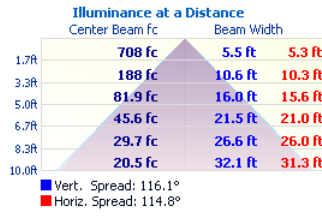

SS-3-L54-SC

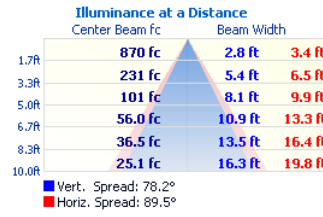

SS-3-L54-SF

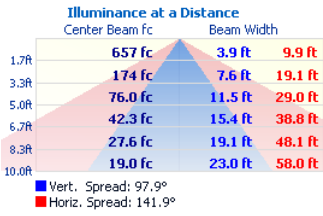

SS-3-L54-RC

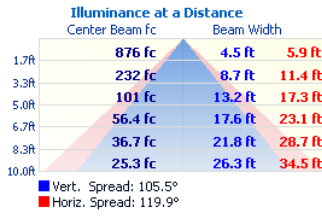

SS-3-L54-RF

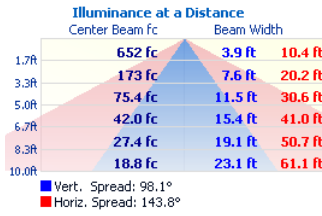

SS-3-L13-SC

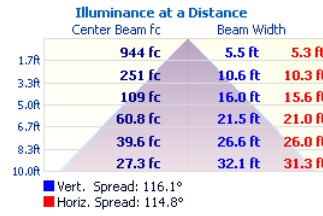

SS-4-L27-SC

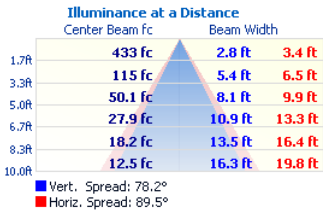

SS-4-L27-SF

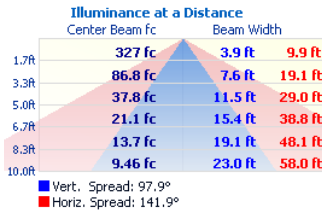

SS-4-L27-RC

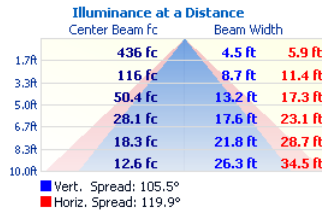

SS-4-L27-RF

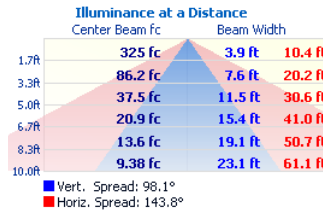

SS-4-L27-NLE

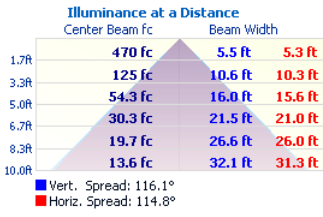

SS-4-L36-SC

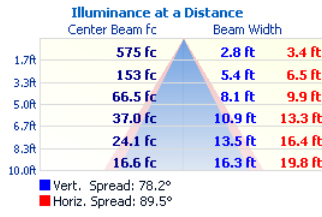

SS-4-L36-SF

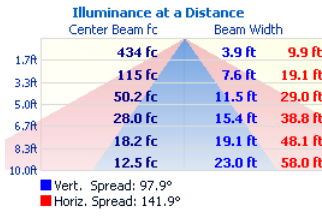

SS-4-L36-RC

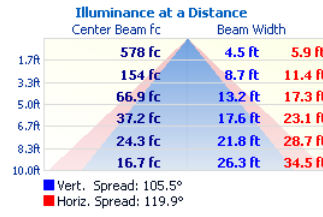



# SS LED

SS-4-L36-RF

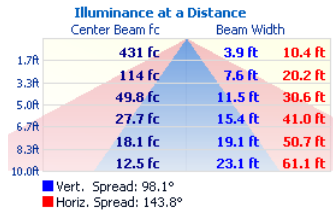

SS-4-L36-NLE

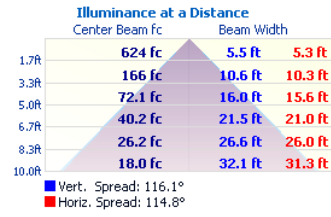

SS-4-L54-SC

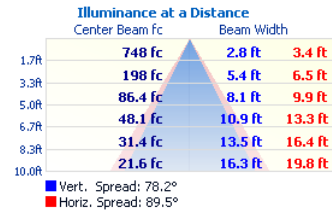

SS-4-L54-SF

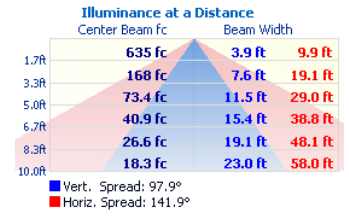

SS-4-L54-RC

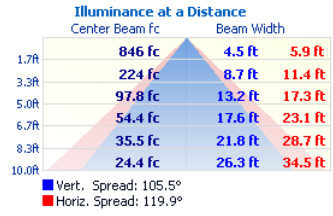

SS-4-L54-RF

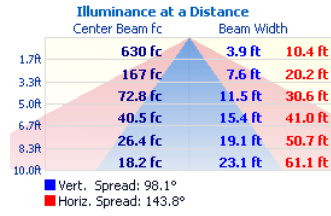

SS-4-L54-NLE

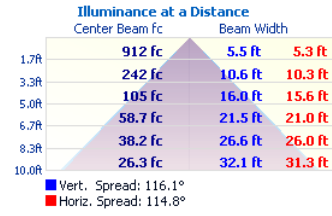

SS-4-L72-SC

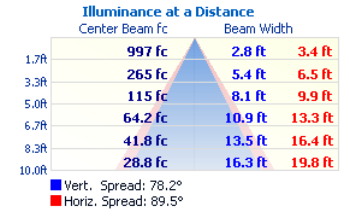

SS-4-L72-SF

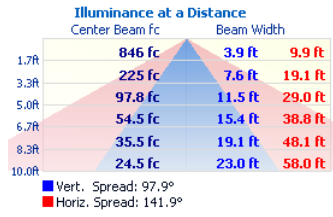

SS-4-L72-RC

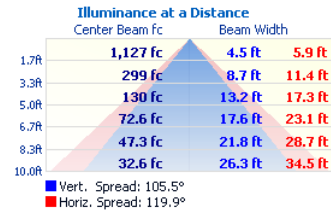

SS-4-L72-RF

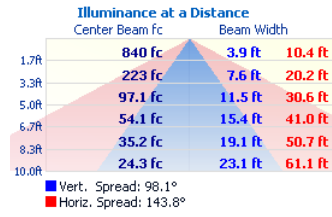

SS-4-L72-NLE

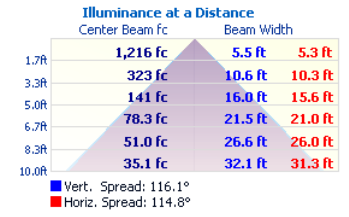

SS-8-L27-SC

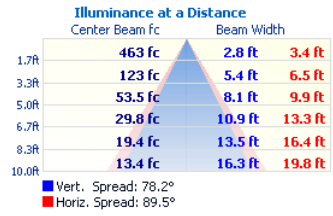

SS-8-L27-SF

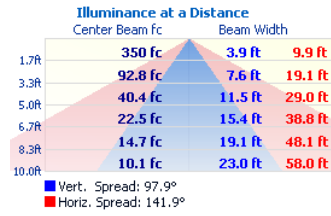

SS-8-L27-RC

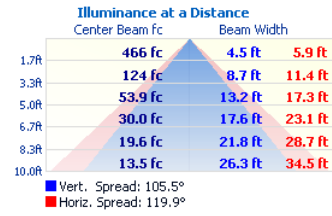

SS-8-L27-RF

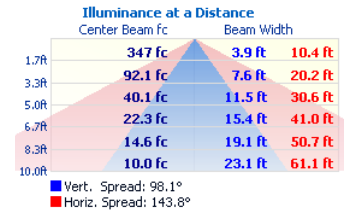

SS-8-L27-NLE

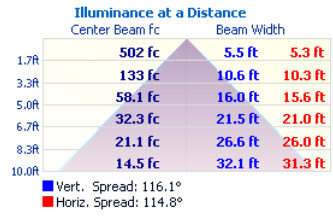

SS-8-L36-SC

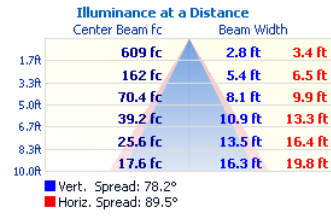

SS-8-L36-SF

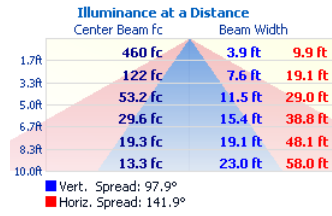

SS-8-L36-RC

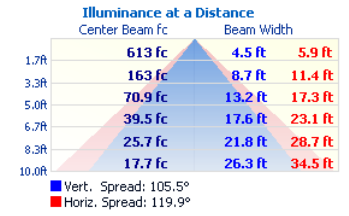

SS-8-L36-RF

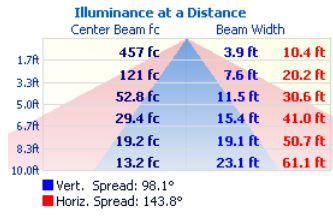

SS-8-L36-NLE

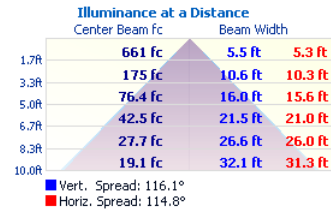

SS-8-L54-SC

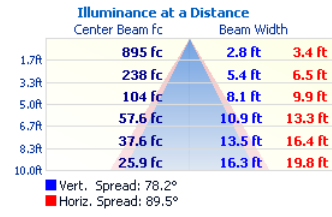

SS-8-L54-SF

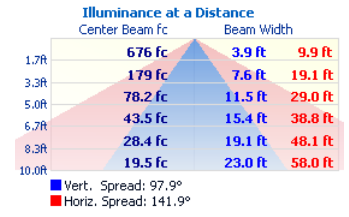



# SS LED

SS-8-L54-RC

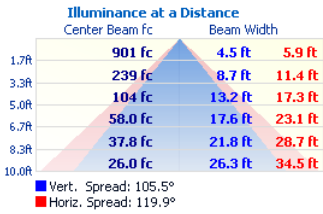

SS-8-L54-RF

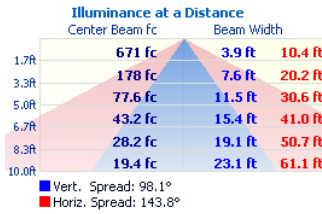

SS-8-L54-NLE

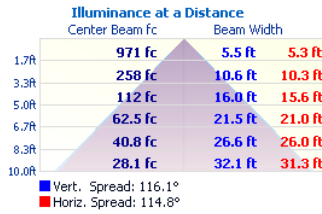

SS-8-L72-SC

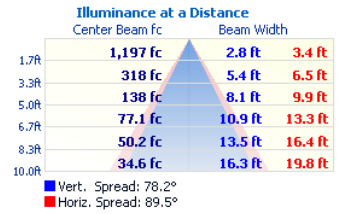

SS-8-L72-SF

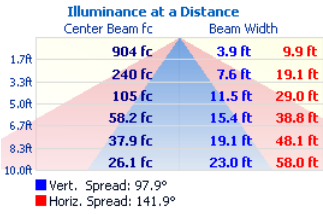

SS-8-L72-RC

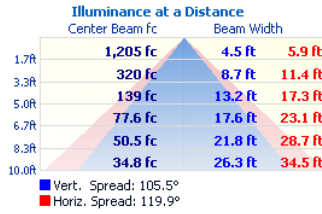

SS-8-L72-RF

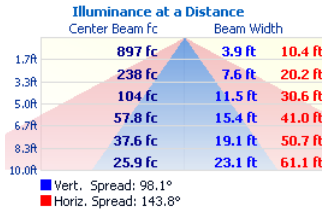

SS-8-L72-NLE

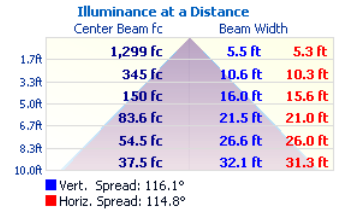

SS-8-L108-SC

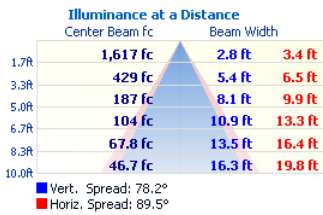

SS-8-L108-SF

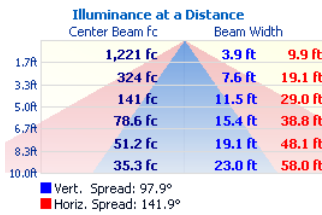

SS-8-L108-RC

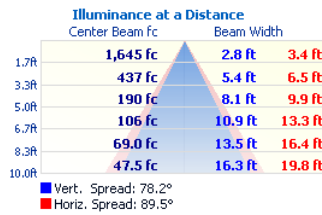

SS-8-L108-RF

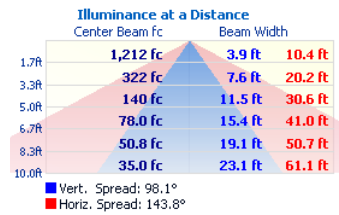

SS-8-L108-NLE

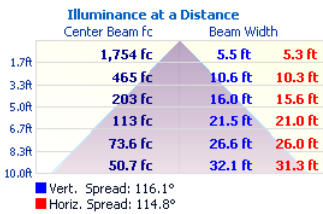

SS-8-L144-SC

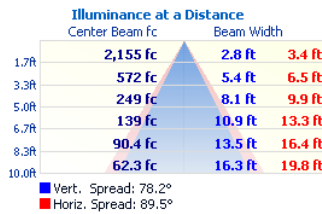

SS-8-L144-SF

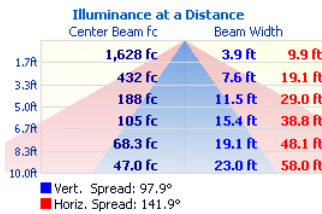

SS-8-L144-RC

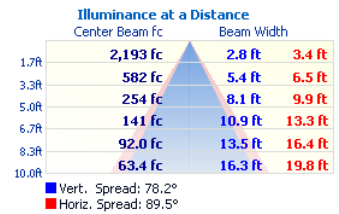

SS-8-L144-RF

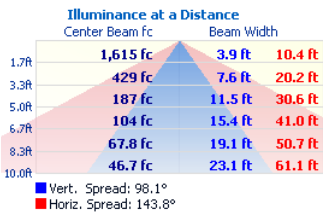

SS-8-L144-NLE

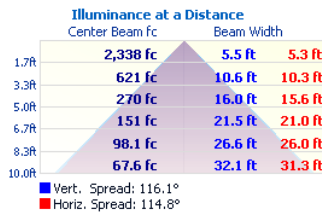

# SS LED

## OUTPUT CURRENT

		Bi-Level		Tri-Level (Default)	
SW1	SW2	Config Range	Default	Config Range	Default
Close	Open	10% - 70%	40%	10% - 70%	30%
Open	Close	10% - 70%	40%	10% - 70%	70%
Close	Close	100%	100%	100%	100%
Open	Open	0%	0%	0%	0%

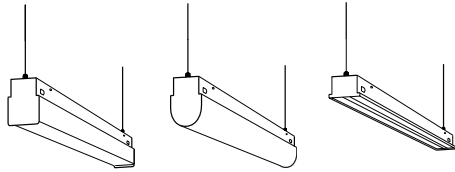

NLE  
Non Lens option

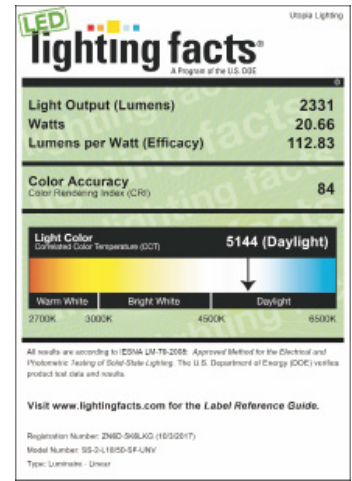
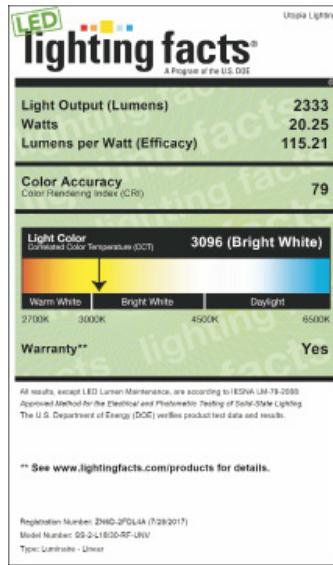

## WIRE GUARD

Pentagon : Available with Round/Square Lens options.  
Square : Available with Non-Lens option.

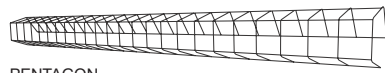

PENTAGON

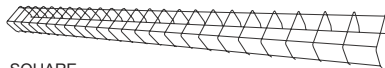

SQUARE

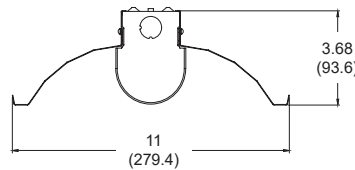

SYM : Symmetric Reflector



ASY : Asymmetric Reflector

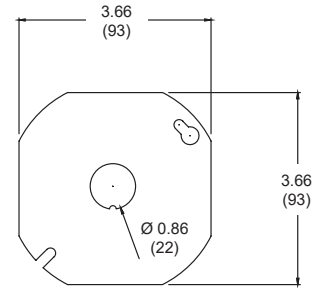

JC4 : Octagon cover plate

## SIDE VIEW

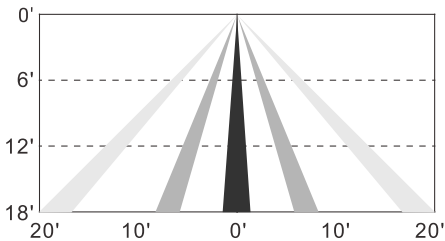

## TOP VIEW

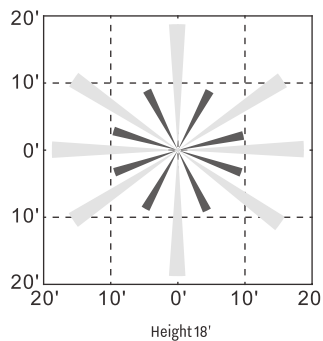

AMS, IFS105SE coverage pattern



Lutron Vive Integral  
fixture control installation



EasySense  
fixture-mount installation



LOS-502S

# SS LED

COMPATIBLE DIMMER SWITCH (TABLE 1)

Model #	Brand	Compatible Dimmer Switch			
GR, PH	Philips Xitanium	<Leviton>	IlumaTech IP7 series		
		<Lutron>	Visit <a href="http://www.lutron.com/advance">www.lutron.com/advance</a> for a list of dimmers (Mark VII) that will work with this driver.		
		<Philips>	Sunrise : SR1200ZTUNV		
OS, OS1	Osram Optotronic	<Osram>	ZBHA-CLM DIM (NAMED: 45678), 45561 - LC-SL3W-TVWBX/UNV		
		<Encelium EMS>	EN-LCM-1R10V-GB2-BK, EN-LCM-1R10V-GB2-BK/DR, EN-ALC-1R10V-GB2-BK, EN-ALC-1R10V-GB2-BK-DR		
		<Leviton>	IP710-DLX		
		<Lutron>	DVTV-XX		
		<Wattstopper>	ADF-120277, FD-301, FSP-202		
		<Synergy>	ISD BC		
		<Busch-Jaeger>	2112U-101		
ES566	eldoLED SOLOdrive	<Jung>	240-10		
		<Leviton>	IlumaTech - IP710-DLX		
		<Lightoller Controls>	ZP600FAM120		
		<Merten>	5729		
		<Pass & Seymour>	CD4FB-W		
		<Wattstopper>	DCLV1		
		<Sensor Switch>	nIO EZ		
		<Synergy>	ISD BC		
		<ABB>	SD/S 2.16.1		
		<Lutron>	Nova T: NTFTV Divia - DVTV-xx, NFTV GRAFIK Eye: GRX-TVI w GRX3503 Energy Savr Node: QSN-4T16-S TVM2 Module		
		<Crestron>	GLX-DIMFLV8, GLXP-DIMFLV8, GLPAC-DIMFLV4-*, GLPAC-DIMFLV8-*, GLPP-DIMFLVEX-PM, GLPP-1DIMFLV2EX-PM, GLPP-1DIMFLV3EX-PM, DIN-AO8, DIN-4DIMFLV4, CLS-EXP-DIMFLV, CLCI-1DIMFLV2EX		
		LDE1	Lutron Hi-lume 1% EcoSystem	<Lutron>	PowPak Dimming Modules: RMJ-ECO32-DV-B, FCJ/FCJS-ECO <sup>1,2</sup> Energi Savr Node (120V only): QSN-1ECO-S, QSN-2ECO-S GRAFIK Eye QS/Homeworks QS control unit (120V only): QSGRJ- E(wireless) QSGR- E Quantum Hub (120V only): QP2-__ _2C/4C/6C/8C Homeworks QS/myRoom Plus power module (120V only): LQSE-2ECO-D
				<Lutron>	Single Rocker Self-Powered Light Switch (on/off, dim-up/down) Ilumra# ZBT-S1AWH Digi-Key# 1082-1033-ND Dual Rocker Self-Powered Light Switch (on/off, dim-up/down, scene1,2) Ilumra# ZBT-S2AWH Digi-Key# 1082-1034-ND
		TDM	KEYSTONE	<Lutron>	Divia DV-600P, SkyLark S-600P, Ariadni AY-600P, Ariadni TG-603P, Maestro MA-600 (Digital), Divia CFL/LED DVCL-153P, Satin Colors DVSC-600P-SW
<Leviton>	6641, IlumaTech IPI06-1LX, ToggleTouch TGI06-1LW (Digital)				
ELV	KEYSTONE	<Lutron>	MAELV-600BL (Digital), DVELV-300P, SkyLark SELV-300P		
ED560	eldoLED DUALdrive	<Lunatone>	SS-LUNAT PS2 30mA, SS-LUNAT Touch or BT, SS-LUNAT Comm		

NOTES:

- All devices connected to one FCJ/FCJS-ECO will be controlled together. Devices will dim to the same level as the result of a control command. For more detail on adjusting low-end light level refer to Application Note#556 at [www.lutron.com](http://www.lutron.com).
- For the Line/Hot (L/H) terminal on the driver, it is preferred not to use the switched hot (red) wire from the control but rather the hot wire directly from the power source.
- Recommended for EasySense System.

# SS LED

Specifications: SS-2  
Weight: 4.7 lbs (2.13 kg)

Specifications: SS-4  
Weight: 6.9 lbs (3.13 kg)

Specifications: SS-8  
Weight: 10.43 lbs (4.73 kg)

**END VIEW**

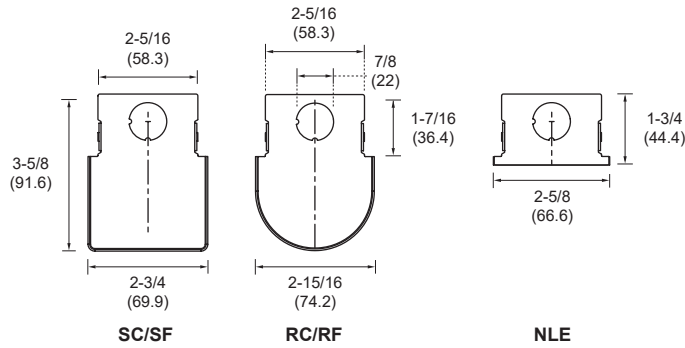

All dimensions are in inches (millimeters).

**TOP VIEW**

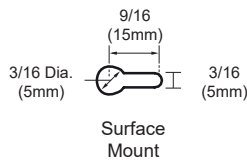
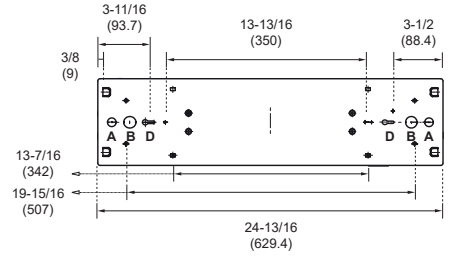

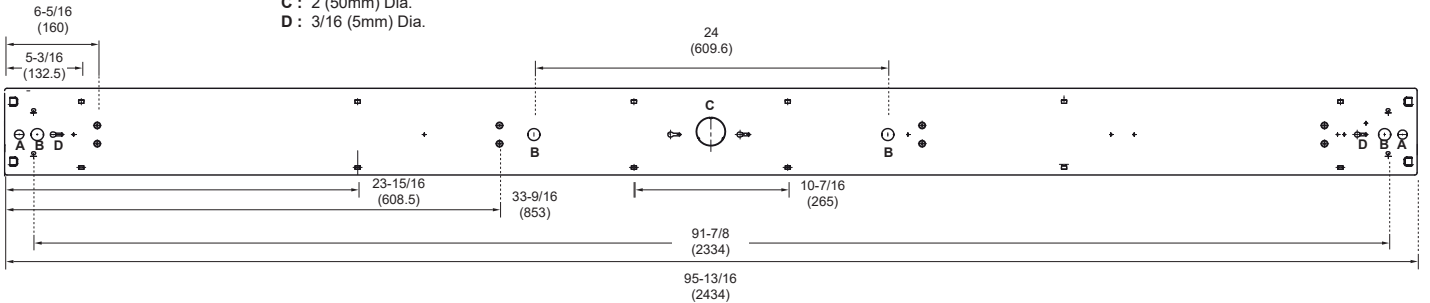
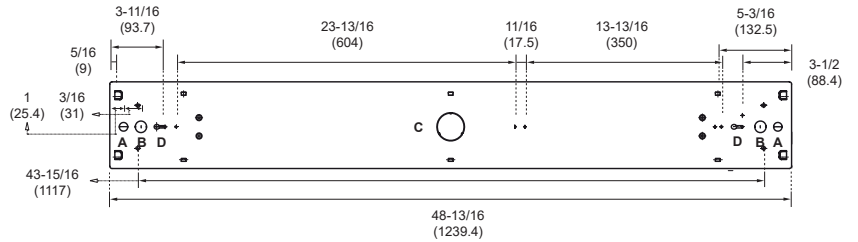

- A : 11/16 (17mm) Dia.
- B : 7/8 (22mm) Dia.
- C : 2 (50mm) Dia.
- D : 3/16 (5mm) Dia.

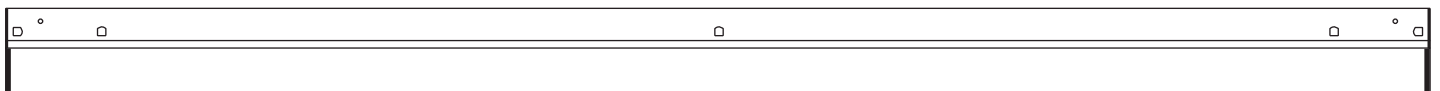
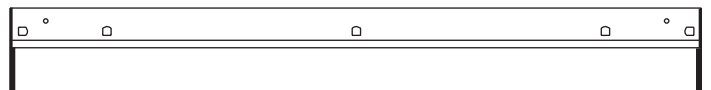
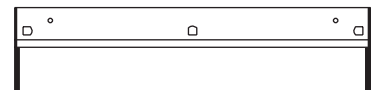

**SIDE VIEW**

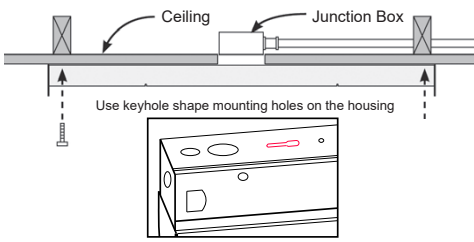
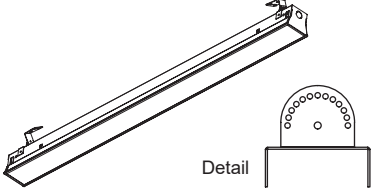
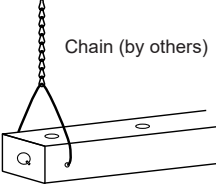
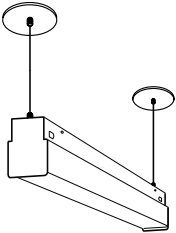
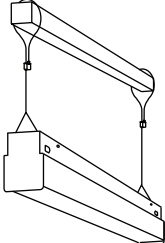
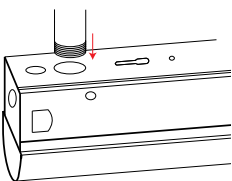

# SS LED

Mounting Options	Image	Ordering Code
Surface Mount (Ceiling)	 <p>Ceiling</p> <p>Junction Box</p> <p>Use keyhole shape mounting holes on the housing</p>	(Blank)
With RB mounting bracket	 <p>Detail</p>	RB
V-hook for Chain Mount	 <p>Chain (by others)</p>	VH
Adjustable Cable Mount (Canopy and cord included)		ACxx xx = Length of Cable (48 or 96 inches)
Adjustable Aircraft Y-cable with Toggles (Canopy and cord not included)		YCxx xx = Specify length in inches (60, 120, 180)
Stem Mount (w/ Canopy)		w/ Canopy HOLE A : 3/8" IPS STEM [ Example : SH-3/8-xx(length) ] HOLE B : 1/2" IPS STEM [ Example : SH-1/2xx(length) ] xx = 18, 24, 36, 48 (inches)
T-Bar Surface Mount		IDS

\* Cable / Stem mount provided with canopy set

# SS LED

