



BEFORE YOU BEGIN

Read and follow all safety instructions



WARNING

RISK OF FIRE, EXPLOSION AND ELECTRIC SHOCK

- This product should be installed, inspected, and maintained by a qualified electrician only, in accordance with the NEC (National Electric Code) and all local codes.
- Turn off electrical power before inspection, installation or removal.
- Use only UL (or other NRTL) approved wire for input/output connections.
- Make sure LEDs and drivers are cool to touch when performing maintenance.
Make sure the supply voltage is the same as the rated voltage of the luminaire.
- Do not install in a hazardous atmosphere, except where the ambient temperature does not exceed the rated operating temperature of the fixture.
- Keep tightly closed when in operation



Prepare Electrical Wiring



Electrical Requirements

Must check if the local voltage range is correspond with the working voltage of the fixture. Use min. 75°C supply.



Grounding Instructions

The grounding and bonding of the overall system shall be done in accordance with NEC Article 600 and local codes.



Follow all applicable safety procedures and use Personal Protective Equipment such as hardhats, safety glasses, reflective vest, electrical safety gloves, fall protection equipment and safety toe boots during the installation, operation, and maintenance of the luminaire.





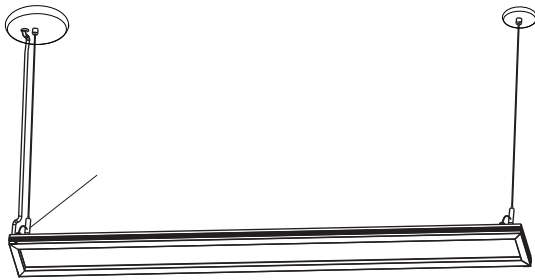

Individual Run Installation

Hard Ceiling (Drywall) Installation



All dimensions are in inches (millimeters).

1 Accessory			
			
2" Non-power canopy kit	4" Power canopy kit	Mounting bracket	Butterfly Drywall Anchor

1) Canopy accessories required for hard ceiling (drywall) installation.

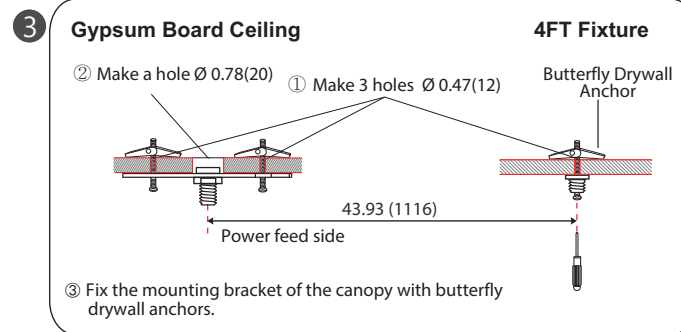
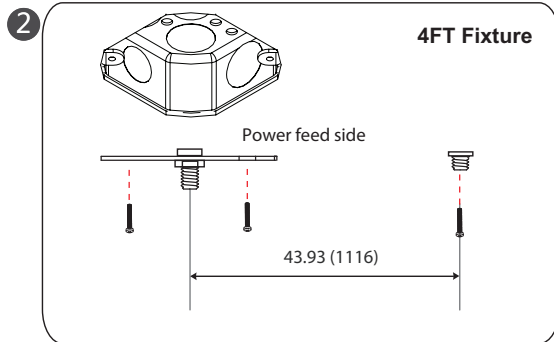

FIG. 1

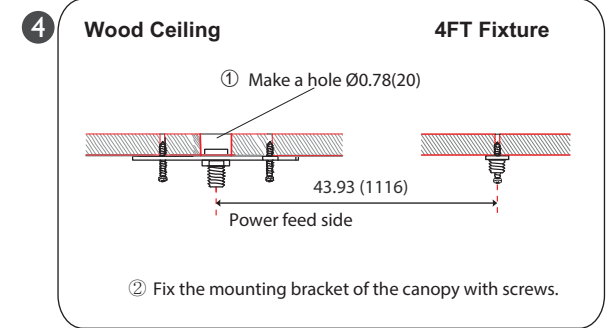
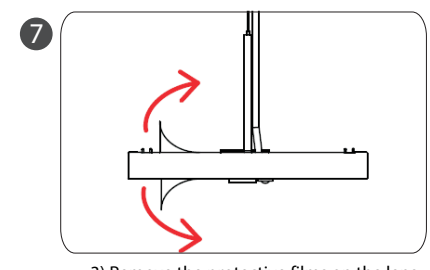
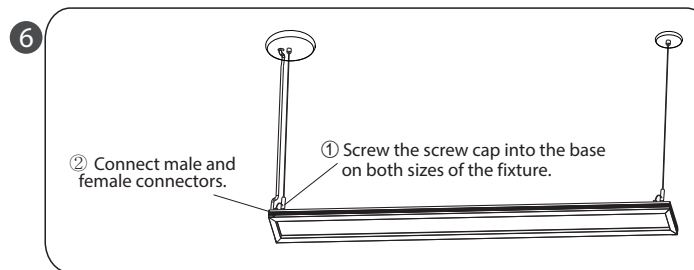
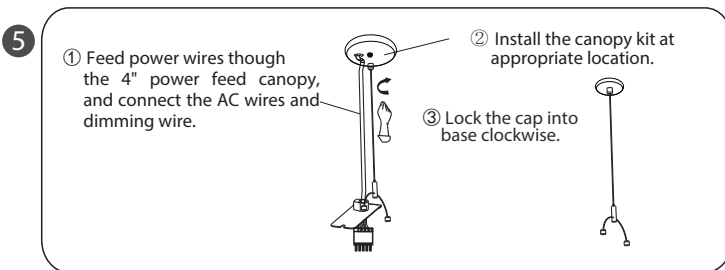

FIG. 2

2) Check the mounting distance and follow the canopy instructions [Fig.1 and Fig.2] by your ceiling type.







TP LED

INSTALLATION INSTRUCTIONS

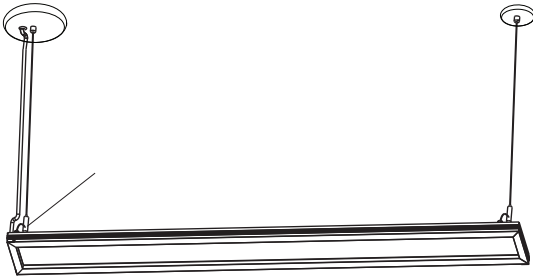
Individual Run Installation

T-Bar Ceiling Installation



1		
Accessory		
		
2" Non-power canopy kit	4" Power canopy kit	T-Grid mounting hanger

1) Canopy accessories required for T-bar Ceiling installation.

All dimensions are in inches (millimeters).

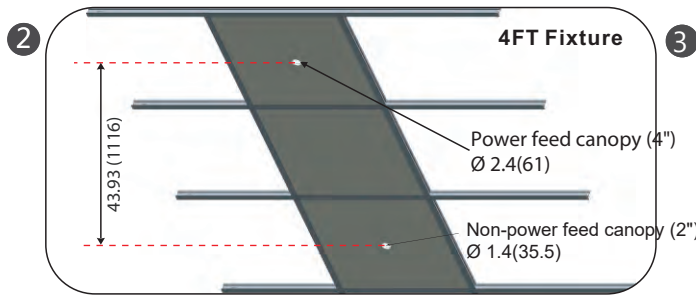

2) Mark and make holes on the ceiling.

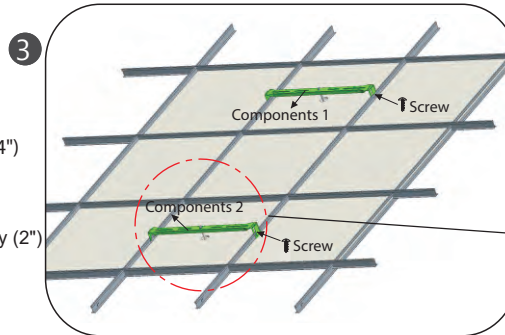

3) Secure the mounting hangers on T-grids.

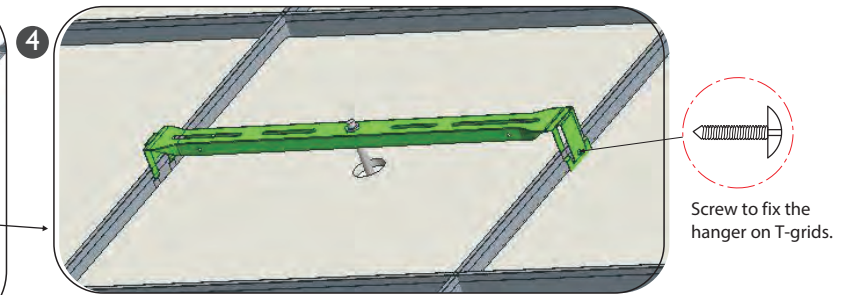

4) Adjust any gap if necessary.

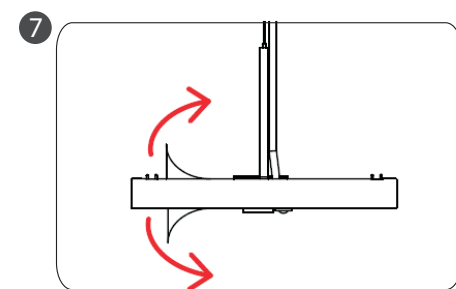
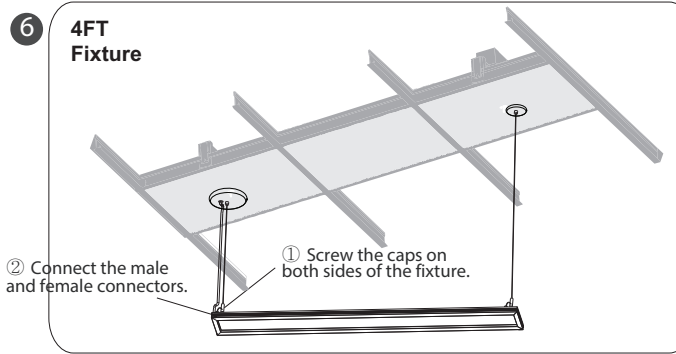
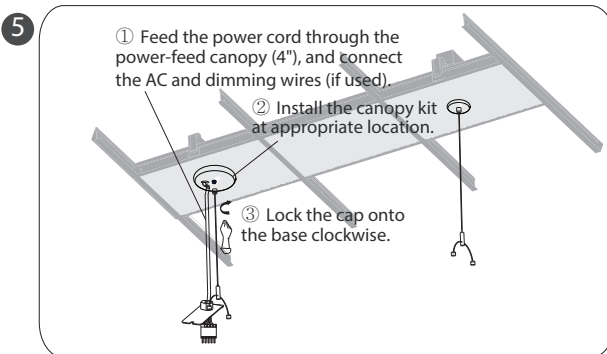

5) Remove the protective films on the lens.

TP LED

INSTALLATION INSTRUCTIONS

Continuous Run Installation

* Max. continuous run of the 4FT fixtures is 36FT total in 120Vac, 80FT total in 277Vac.

* Only the first run will have a power feed cord.

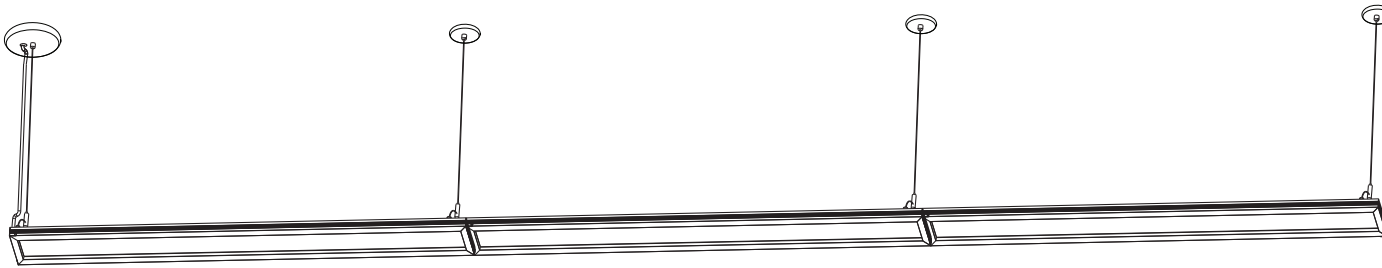

All dimensions are in inches (millimeters).

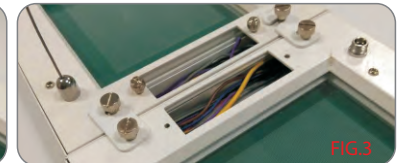
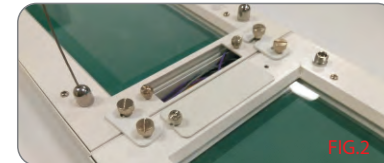
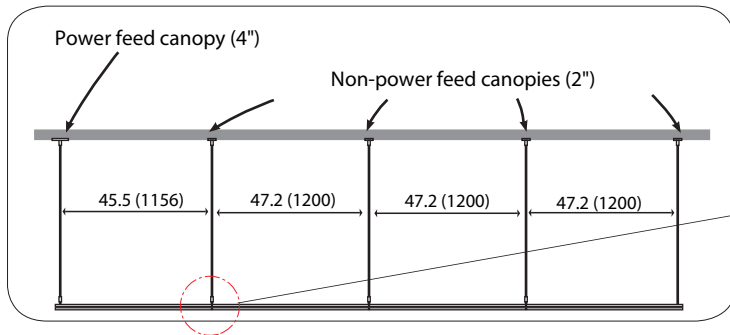

- 1) Except for the first run of the continuous run, remove the plate and AC cord, and disconnect male and female connector [Fig.1].
- 2) Join the following run fixture and fix with the joint clip [Fig.2].
- 3) Pull out and connect male and female connector [Fig.3, 4].
- 4) Close with a wire cover plate [Fig.5].



TP LED

INSTALLATION INSTRUCTIONS

WIRING DIAGRAM

